



Ministry of Business,
Innovation & Employment

THE GUIDE FOR CANTERBURY BUILDERS

BELOW-FLOOR WORK

[Your new best friend]



About this booklet

This booklet, *Below-Floor Work*, and its companion booklet *Above-Floor Work*, are for builders and others wanting an overview of requirements for repairing and rebuilding houses in the Canterbury Green Zone. They outline the regulatory requirements for builders, and highlight special issues for working in the Canterbury Green Zone.

These booklets are an introduction to the more detailed guidance published by the Ministry of Business, Innovation and Employment (MBIE): *Repairing and rebuilding houses affected by the Canterbury earthquakes* (MBIE Guidance).

Links are provided to the MBIE Guidance, which should be referred to for more detailed information.



BUILD IT RIGHT
CANTERBURY | The groundwork
for good decisions.

Disclaimer: This document is a guide only. It should not be used as a substitute for legislation or legal advice. The Ministry of Business, Innovation and Employment is not responsible for the results of any actions taken on the basis of information in this document, or for any errors or omissions.

© Crown Copyright 2013

BELOW-FLOOR WORK:

FOUNDATIONS FOR TIMBER STRUCTURES

If you're building in Canterbury...this is important!

Repairing a post-earthquake building is different from carrying out day-to-day repairs. Floor structures may have been twisted, wrenched, cracked or tilted so much that their repair, releveling or replacement must be considered before any other repairs are done.

In most cases, decisions regarding any earthquake repairs on houses in Canterbury will be made by a Project Management Office (PMO), designer, or engineer.

They will engage builders on behalf of the building's insurers or owners to undertake those repairs – under usual building contract terms and conditions.

This booklet, *Below-Floor Work*, is an introduction to MBIE's guidance for repairing or replacing foundations and gives links to more detailed information. MBIE published the guidance *Repairing and rebuilding houses affected by the Canterbury earthquakes* to support a quality rebuild in Canterbury. It is available at www.dbh.govt.nz/guidance-on-repairs-after-earthquake



The MBIE Guidance can be viewed online

What this booklet covers

The booklet sets the scene for building in Canterbury's Green Zone and gives an overview of the 'nuts and bolts' of below-floor work.

It covers the repair and replacement of foundations for residential properties that are mainly:

- One or two storey timber-framed dwellings
- Located on sites on the flat in Canterbury's Green Zone.

It also covers garages and outbuildings, and gives tips for installing new services.



Refer to MBIE Guidance Introduction and Part C, section 11 – Introduction to TC3.

ALERT: THE COMPANION GUIDE, ABOVE-FLOOR WORK, COVERS REPAIRS TO THE REST OF THE BUILDING (INCLUDING CHIMNEYS AND RETAINING WALLS). IT IS IMPORTANT THAT FOUNDATIONS AND GROUND FLOORS ARE REPAIRED OR REPLACED BEFORE STARTING ANY ABOVE-FLOOR REPAIR OR REBUILDING.

ALERT: REPAIRING OR REBUILDING EARTHQUAKE-DAMAGED HOUSES MAY INVOLVE SPECIFIC ENGINEERING DESIGN. THERE IS MORE INFORMATION UNDER SPECIFIC ENGINEERING DESIGN – WHEN IT IS REQUIRED, AND THERE IS MORE DETAIL PROVIDED IN THE MBIE GUIDANCE.

CONTENTS

SETTING THE SCENE

Building in the Canterbury Green Zone	5
NZ Regulations	9

THE NUTS AND BOLTS

Below-floor work	14
Assessing house foundations	14
Confirming the site's Technical Category (TC)	15
Assessing foundation damage – repair or replace?	16
Checking ground height requirements	18
Repairing and releveling foundations in TC1 and TC2	20
Lifting and releveling floors: all foundation types	21
Releveling Type A foundations: timber floor with piles	22
Releveling Type B foundations: timber floor with piles and perimeter foundation	26
Releveling Type C foundations: concrete slab-on-ground	26
Putting in new foundations	28
Other useful information	37

SETTING THE SCENE.



BUILDING IN THE CANTERBURY GREEN ZONE

Lessons learned from building performance in the Canterbury earthquakes have led to some improvements in the way houses are designed and constructed.

Generally, house framing and bracing performed well; especially for housing sites on the flat. In most cases there was only minor structural damage, along with damage to finishes, services, and site works.

However, the performance of some house foundations on flat sites was less successful, mainly due to liquefaction, stretching over the building footprints (lateral spreading), and tilting of floors (differential ground settlement). So, more attention is being paid to ground conditions and foundation design.

The Technical Categories – or “TCs”

The main changes that affect repairing and rebuilding houses damaged in the Canterbury earthquakes relate to the land’s Technical Category.

Flat areas of the Canterbury Green Zone are divided into three Technical Categories, or TCs.

.....

NOTE: THESE CATEGORIES PROVIDE A GUIDE TO THE LEVEL OF SITE INVESTIGATION REQUIRED AND THE APPROPRIATE FOUNDATIONS FOR THE HOUSE.

.....



Each property is listed in one of the following:

- **TC1** is where land damage from liquefaction is unlikely in future large earthquakes. Standard residential foundation assessment and construction is appropriate.
- **TC2** is where liquefaction damage is possible in future large earthquakes. Shallow ground investigations may be required when repairing or replacing foundations. There are foundation repair and rebuild options in the MBIE Guidance.
- **TC3** is where liquefaction damage is possible in future large earthquakes. Geotechnical engineering assessment may be required to select the appropriate foundation repair or rebuild.

 For more about the TCs, see MBIE Guidance section 1.4.3 – Technical scope, and Part C, section 12 – Future land performance in TC3.

Confirming the TC is an important starting point before doing repairs, especially for foundations. The TC will indicate which recommendations in the MBIE Guidance are best suited for the site.

 **Helpful tip:** Find out the Technical Category and other land information for residential sites at the CERA website www.landcheck.org.nz



Specific Engineering Design – when it is required

Specific engineering design is when the design or design method is non-standard (i.e. outside the Acceptable Solution or Verification Method).

See page 9 *The Building Code and Building Consents*.

Specific engineering design will usually be done by a Chartered Professional Engineer (CPEng).

The MBIE Guidance recommends specific engineering design in a number of circumstances. Examples are:

- **TC3:** Designs for new or repaired foundations in TC3 zone generally require specific engineering assessment or design.
- **Hillside properties:** Foundation repairs for hillside properties are likely to be more complex and won't lend themselves to a standard approach. A professional engineer will usually be engaged to advise on the stability, repair or replacement of any foundations for hillside properties.
- **Masonry foundation walls:** Repairs to damaged concrete block and brick masonry walls will depend on whether or how the walls are reinforced and the amount of grouting used (some block walls may be only partially filled and double skin brick masonry is usually unfilled).

Specific engineering advice is required for assessing damage to *unreinforced* brick or block masonry walls.

.....

NOTE: MINOR CRACKING IN REINFORCED (TWO-WAY REINFORCED) CONCRETE BLOCK WALLS, THAT ARE WELL ATTACHED TO THE SURROUNDING STRUCTURE, CAN USUALLY BE REPAIRED BY GROUT OR EPOXY INJECTION AND REPOINTING WITHOUT SPECIFIC ENGINEERING DESIGN.

MORE EXTENSIVE CRACKING IN REINFORCED AND UNREINFORCED WALLS USUALLY MEANS REPAIRS ARE NOT PRACTICAL AND REPLACEMENT IS PROBABLY THE ONLY OPTION.

.....

- **Pole frame structures:** Foundation repairs to pole frame structures will need specific engineering design.

 Refer MBIE Guidance section 7.6 for outlines of typical damage location and repair options for pole frame structures.

ALERT: REPAIRING OR REBUILDING A TIMBER-FRAMED HOUSE GENERALLY NEEDS SPECIFIC ENGINEERING DESIGN IF:

- THE BUILDING IS MORE THAN TWO STOREYS HIGH OR MORE THAN 10 METRES ABOVE GROUND
- THE BUILDING WORK INVOLVES FOUNDATIONS FOR SITES IN THE TC3 ZONE.

Specific engineering design will usually be done by a Chartered Professional Engineer (CPEng).

.....
NOTE: IF A BUILDING NEEDS EXTENSIVE REPAIRS – ESPECIALLY IF REPAIRS ARE TO ITS STRUCTURE, ROOF, WALL CLADDING, WINDOWS OR DOORS – A PROFESSIONAL ENGINEER, ARCHITECT OR DESIGNER WILL GENERALLY BE INVOLVED.

Some useful links:

- **Concrete or concrete block construction:** refer to NZS 4229 *Concrete masonry buildings not requiring specific engineering design*, and to the Cement and Concrete Association of New Zealand’s Code of Practice CCANZ CP 01:2011, available at www.ccanz.org.nz
- **Steel stud construction:** refer to the National Association of Steel-framed Housing Handbook – *Best practice for design and construction of residential and low-rise steel framing*, available at www.nash.asn.au

NZ REGULATIONS

The Building Code and Building Consents

The Building Act 2004 (Building Act) contains provisions that are designed to ensure buildings are safe and healthy to live in.

The Building Code (established under the Building Act) sets the performance standards that all building work must meet.

The Building Code is divided into clauses (sections) covering each aspect of a building, such as structure, fire and weathertightness.

Each Clause of the Building Code has at least one Acceptable Solution or Verification Method (see www.dbh.govt.nz/compliance-documents). These are ready-made design solutions, that you can use to comply with the Building Code. However, these solutions are not mandatory and following them is only one way of complying with the Building Code.

ALL building work MUST comply with the Building Code, whether or not it requires a building consent.

 For more information on the regulatory context for the Canterbury earthquake repairs, refer MBIE Guidance Part B, section 8.2 – Regulatory requirements, and Appendix C1 – Basis for confirming compliance with the Building Code for new and repaired house foundations in TC3.

Work that MUST HAVE a Building Consent

All new building work will need a building consent, except the minor work covered by Schedule 1 of the Building Act (see next page).

Work that must have a Building Consent includes:

- Repairs or replacement of structural components (however, some minor structural repairs may not need a building consent – check with the local building consent authority)

- Repairs or replacement of fire safety parts of a building
- Replacing materials that have failed to meet the durability requirements of the Building Code, such as a leaking roof or wall cladding that is less than 15 years old.

.....
NOTE: REPAIRS OR MAINTENANCE OF MATERIALS SUCH AS CLADDINGS THAT HAVE FAILED DUE TO EARTHQUAKE DAMAGE, DO NOT REQUIRE A BUILDING CONSENT.

Work that DOES NOT require a Building Consent

Some minor building work does not require a building consent – this is known as ‘exempt building work’. A list of exempt work is contained in Schedule 1 of the Building Act (for more details see below).

For building repairs, exempt work generally includes:

- Repair or replacement of building components or building services using materials that are the same, or comparable, to existing materials
- Construction, repair or replacement of walls with less than 1.5 metres of retained ground, that are (1) back-filled no higher than the wall, and (2) do not support loads other than the backfilling. See *Above-Floor Work – Retaining Walls*
- Construction, repairs or replacement of a deck which is less than 1.5 metres from the ground at any point
- Installation, replacement, or removal of a door or window
- Non-structural internal alterations and repairs (repairs to internal wall lining used for bracing do not need a building consent)
- Any other building work which the territorial authority (local council) considers to be exempt (these can be general or case-by-case exemptions under Schedule 1(k) of the Building Act).

ALERT: FOR A COMPLETE LIST OF WORK THAT DOES NOT REQUIRE A BUILDING CONSENT REFER TO:

- WWW.LEGISLATION.GOV.T.NZ (BUILDING ACT SCHEDULE 1)
- WWW.DBH.GOV.T.NZ/BC-NO-CONSENT
- WWW.CCC.GOV.T.NZ/HOMELIVING/BUILDINGPLANNING/BUILDINGCONSENTS/EXEMPTION.ASPX

REMEMBER THAT, EVEN WHEN A BUILDING CONSENT IS NOT REQUIRED, ALL BUILDING WORK MUST STILL COMPLY WITH THE BUILDING ACT AND THE BUILDING CODE.

What you are legally responsible for

If you are carrying out residential building repairs or new building work under a building contract, you are legally responsible for ensuring that the work:

- Is properly carried out and completed
- Complies with the agreed contract terms
- Is suitable for its intended purpose.

ALERT: THESE ARE KNOWN AS IMPLIED WARRANTIES FOR THE QUALITY OF YOUR WORK. YOU CANNOT CONTRACT OUT OF THESE (SEE SECTIONS 397 AND 399 OF THE BUILDING ACT).

If you are designing or giving advice on building work, you are also legally responsible for that advice. Builders who both design and carry out repairs to buildings are therefore legally responsible for the work complying with the Building Code.

.....
NOTE: IT IS IMPORTANT FOR BUILDERS TO BE AWARE OF THEIR LEGAL RESPONSIBILITIES, ESPECIALLY IF DOING REPAIRS WITHOUT A BUILDING CONSENT. REFER TO WORK THAT DOES NOT REQUIRE A BUILDING CONSENT.

GETTING A BUILDING CONSENT IS ONE WAY OF MAKING SURE THE WORK COMPLIES WITH THE BUILDING CODE.

Restricted Building Work and Licensed Building Practitioners

Restricted Building Work, is building work that MUST be carried out by a Licensed Building Practitioner (LBP). It only applies to houses or apartment buildings up to 10 metres in height and excludes mixed-use apartments.

If you are an LBP

You can do Restricted Building Work you are licensed for, relating to:

- The dwelling's structure, such as work on foundations, framing and bracing
- Its weathertightness, such as building work relating to windows, doors, roofing, cladding
- Some fire safety design work.



Helpful tip: Go to www.dbh.govt.nz/builditright for more about Restricted Building Work and Licensed Building Practitioners.

LBPs, once they have completed their part of the Restricted Building Work, must provide a "Record of work" form confirming which parts of the Restricted Building Work they carried out or supervised. LBPs must give this form to homeowners and the territorial authority (local council).

If you're NOT an LBP

If you are not an LBP, you can carry out Restricted Building Work UNDER THE SUPERVISION OF AN LBP licensed for the work.

You can also carry out:

- Work not considered Restricted Building Work
- Work that does not require a building consent
- Any work on buildings that are not used for living in, such as sheds, stand-alone garages and carports.

THE NUTS AND BOLTS.



BELOW-FLOOR WORK

Assessing house foundations

This booklet, and the more detailed MBIE Guidance: *Repairing and rebuilding houses affected by the Canterbury earthquakes*, cover repairs to house foundations on flat sites in Canterbury's Green Zone.

First, foundations must be checked for damage to establish what's required to repair or replace them. This includes:

- Establishing the site's TC and checking visible land damage
- Assessing foundation damage – repair or replace
- Checking ground height requirements.

ALERT: THIS INFORMATION IS PROVIDED AS CONTEXT FOR BUILDERS AND OTHERS INTERESTED IN THE PROCESS.

REMEMBER THAT, IN MOST CASES, THE ACTUAL DECISIONS REGARDING THE NATURE AND EXTENT OF ANY EARTHQUAKE REPAIRS WILL BE MADE BY A PROJECT MANAGEMENT OFFICE (PMO), DESIGNER, OR ENGINEER. THEY WILL IN TURN ENGAGE BUILDERS TO UNDERTAKE THOSE REPAIRS ON BEHALF OF THE BUILDING'S INSURERS OR OWNERS.



Helpful tip: Repairs in TC3 require specific engineering assessment for foundations. Repairs to foundations for hillside properties will generally need expert advice: see MBIE Guidance section 6 for more information.

Confirming the site's Technical Category (TC)

Confirming the TC for a particular site is important to determine repair requirements for any foundation work.

The TC for properties can be found at CERA website www.landcheck.org.nz

The MBIE Guidance contains information on matching visible land damage at the site.



Also see MBIE Guidance Part A, section 3.3 for more help with this.

- **TC1** – should have no surface damage, liquefaction, or land settlement
- **TC2** – may have cracks less than 50 mm wide, small amounts of liquefaction, or land settlement less than 100 mm
- **TC3** – will be any sites with signs of damage greater than those listed for TC2. TC3 sites require specific engineering assessment.

If the visible signs of damage to a property appear greater than its TC, repair work should be assessed for:

- The requirements of the next highest TC and/or
- Specific engineering design



See MBIE Guidance section 3 for full details.

.....
NOTE: AFTER SPECIFIC ENGINEERING INVESTIGATION, TC3 PROPERTIES MAY BE FOUND TO BE SUITABLE FOR TC2 TYPE FOUNDATIONS.
.....

Assessing foundation damage – repair or replace?

For all TC zones:

- If the damage to existing foundations is within the limits shown in Figures 1 to 3, the foundations can be repaired or relevelled
- If the damage is greater than that shown, foundation replacement is indicated.

FIGURE: 1

ASSESSING PILES

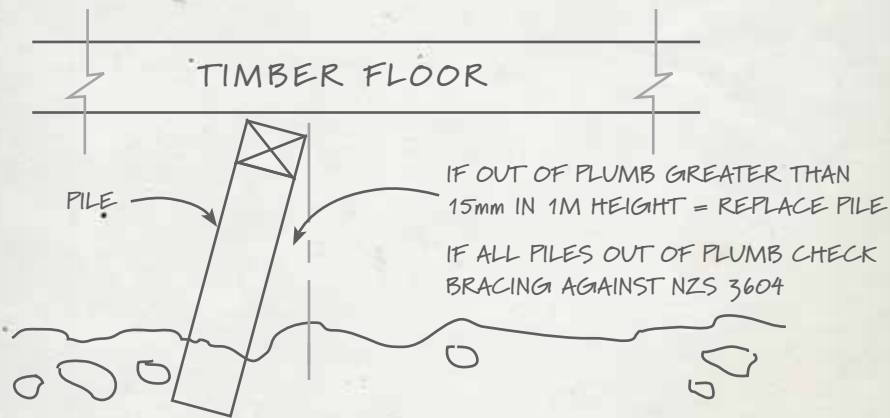

Refer MBIE Guidance Part A, section 2 – Foundation assessment criteria and approaches, Table 2.3 and Figure 2.2 for more detail.

FIGURE: 2

WHEN TO RELEVEL TYPE A AND B FOUNDATIONS (see pages 21-26)

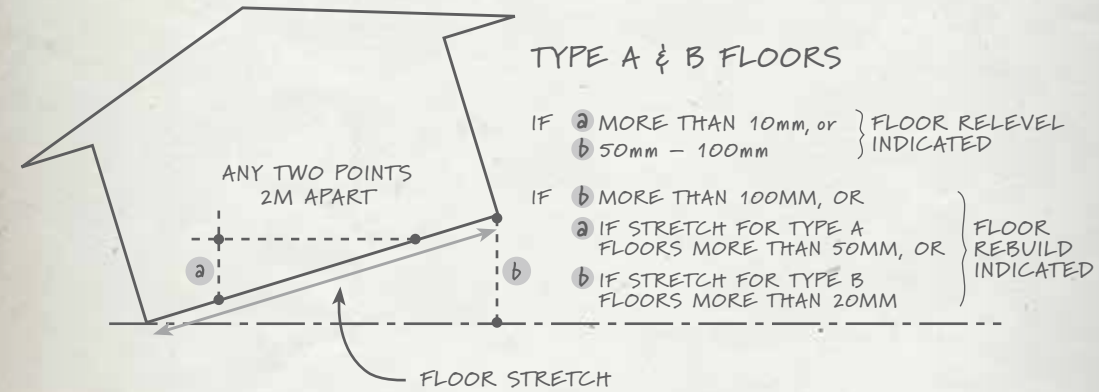
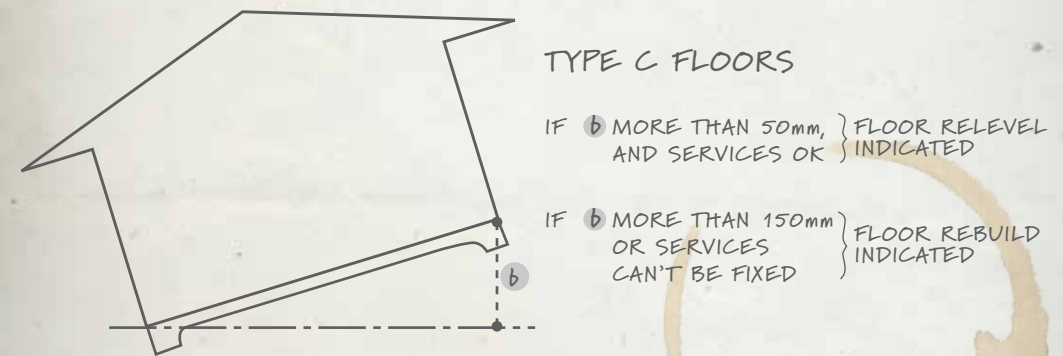

FIGURE: 3

WHEN TO RELEVEL TYPE C FOUNDATIONS - CONCRETE SLABS (see page 26)



Checking ground height requirements

There may be obligations to raise the building's floor levels, under both the Building Code, and the local council's flood management areas (FMA) provisions in their District Plan. If the building footprint is increased, floor levels may need to comply with the Building Code and FMA levels of the local council.

Under the Building Code:

- For new foundations, NZS 3604:2011 sets minimum floor levels above ground (these are summarised in Figure 4)
- For releveling of existing floors, it is usually sufficient to bring floors to the highest existing floor level when it's not practical to meet the ground clearance requirements of NZS 3604:2011.

Under local council flood management provisions:

- Minimum floor levels for new or re-built floors, are set for properties in designated flood management areas (FMAs) at risk of regional flooding (search online for 'Operative Variation 48' or go to www.ccc.govt.nz; or search under Waimakariri District or Selwyn District Plans).

ALERT: NEW FLOORS MAY BE REQUIRED TO MEET BOTH VARIATION 48 OF CHRISTCHURCH CITY COUNCIL'S FLOOD MANAGEMENT PLAN, SET UNDER THE RESOURCE MANAGEMENT ACT, AND REQUIREMENTS OF THE BUILDING CODE. FOR MORE ABOUT MINIMUM FLOOR LEVELS, SEE MBIE GUIDANCE PART A, SECTIONS 2.5, 2.6 AND FIGURE 5.3. ALSO REFER TO SECTION 8.4 FOR FLOOD RISK AND FLOOR LEVELS.

Building insurers, home owners or others may choose to raise floor levels even if it's not required. To do this, they may decide to build new floors or raise existing ones. Setting floor levels above the ground protects the house from localised water entry, protects timber framing from dampness, and allows under-floor access beneath piled floors.



There are limits to the depths of imported fill that may be used to raise floor levels. These limits are to avoid overloading the ground: see MBIE Guidance Part A, section 5.2.

FIGURE: 4

GROUND HEIGHT CLEARANCES FOR NEW FOUNDATIONS

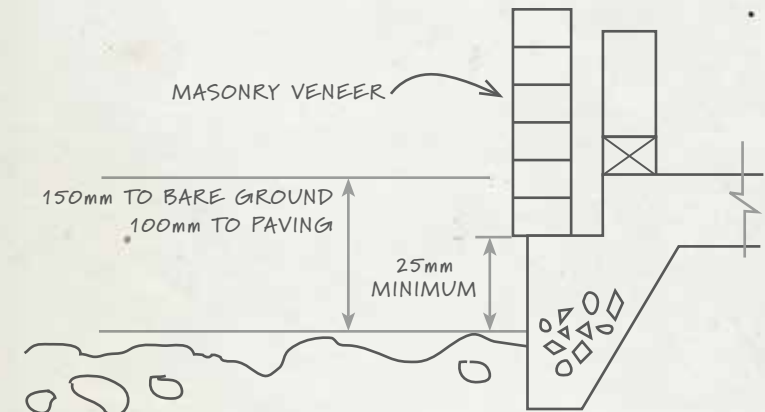
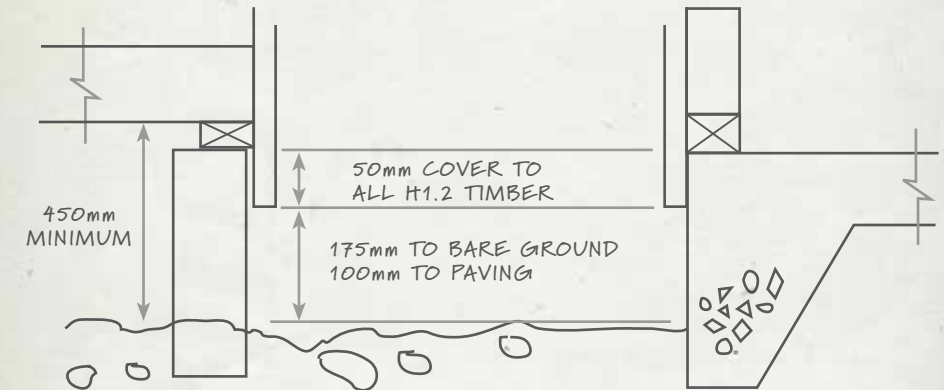

REPAIRING AND RELEVELLING FOUNDATIONS IN TC1 AND TC2

This section gives an overview of some of the work that's likely to be required to repair existing foundations, plus links to the detailed MBIE Guidance. The actual decision-making about the nature and extent of any repairs will generally be done by a Project Management Office, designer or engineer.

Repairing foundations in TC1 and TC2 can generally be done without specific engineering design, and requires only shallow ground testing. Some foundation options in TC2 require specific engineering design.

Foundation repair in TC3 requires specific engineering input and sometimes deep ground assessment.

Existing foundations are usually one of three types:

- Type A: timber floor with piles only
- Type B : timber floor with piles and perimeter foundation
- Type C: concrete slab-on-ground.



See MBIE Guidance Part A, section 2.1 – Typical dwelling foundation types.

A bit about garages and outbuildings

A garage that forms part of a house must be repaired as if it is a house.

Stand-alone garages and outbuildings that are not attached to a house may be repaired or replaced to:

- TC1 requirements if in TC1 or TC2
- TC2 requirements if in TC3
- specific engineering design.

LIFTING AND RELEVELLING FLOORS: ALL FOUNDATION TYPES

Floor lifting and releveling options

Type A foundations	Jack floors and repack piles
Type B and C foundations	Jack floors and/or inject engineering resin or low-mobility grout beneath foundation and floor slabs

Here's a checklist of things to consider when lifting and releveling floors (for all three foundation types):

- Remove floor coverings and house contents in areas of lift
- Set survey equipment for monitoring lift
- Clear working space around perimeter of building
- Detach piles from bearers in areas where packing is required and disconnect any attachments such as external steps, decks or pergolas (whether or not you should lift chimney foundations at the same time using resin or grout injection methods should be assessed case-by-case)
- Detach services if they cannot accommodate lifting heights
- Apply the chosen lifting method (see Guidance reference below)
- Reattach or install new services
- Backfill the ground.



Refer MBIE Guidance Part A, section 4.3, Table 4.1 and Appendix A1 for floor levelling techniques. Also see Part A, section 5.7 for dealing with building services.

Relevelling Type A foundations: timber floor with piles

Here's a checklist of things to consider when relevelling Type A foundations:

- Check ground bearing capacity to NZS 3604:2011 (conduct test bores to 4 metres where possible)
- Remove pile coverboards (if any) and any cladding attachments to foundations
- Disconnect piped services and power, and loosen flexible cables
- Disconnect pile/bearer connections
- Progressively relevel floor and install temporary bracing
- For pile/bearer gaps less than 100 mm, pack with H3.2 timber (see Figures 5A and 5B)
- For pile/bearer gaps greater than 100 mm, replace piles
- Replace any piles out of alignment (see Figure 1)
- Resettle building and connect bearers to piles to NZS 3604:2011 (see figures 5A and 5B)
- Reattach edge cladding, foundation boards and services.

FIGURE: 5A

PACKING ORDINARY PILES:

SEE NZS 3604, SECTION 4 FOR FIXING SELECTION

TIMBER PILES

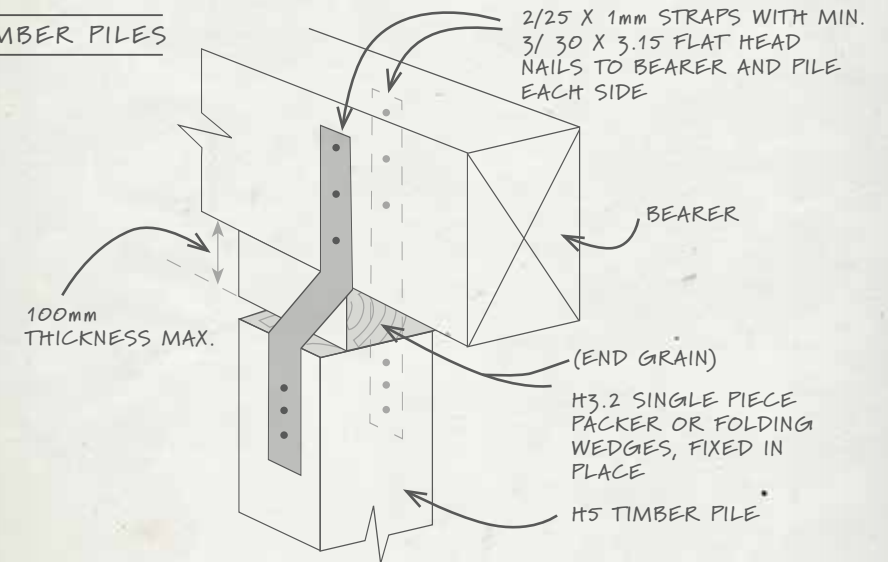

CONCRETE PILES

4mm GALVANISED WIRE AND 3.5 mm GALVANISED STAPLES WHERE SHOWN

TENSIONING STAPLE

H3.2 SINGLE PIECE PACKER OR FOLDING WEDGES (DOTTED), FIXED IN PLACE

100mm THICKNESS MAX. (END GRAIN)

CONCRETE PILE

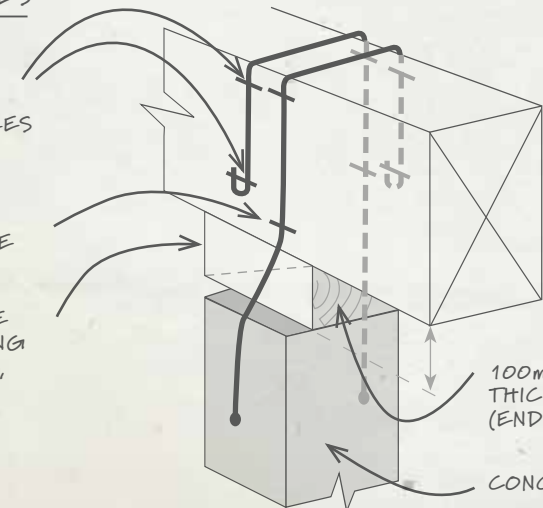

FIGURE: 5B

PACKING FOR ANCHOR PILE:
SEE NZS 3604, SECTION 4 FOR FIXING SELECTION

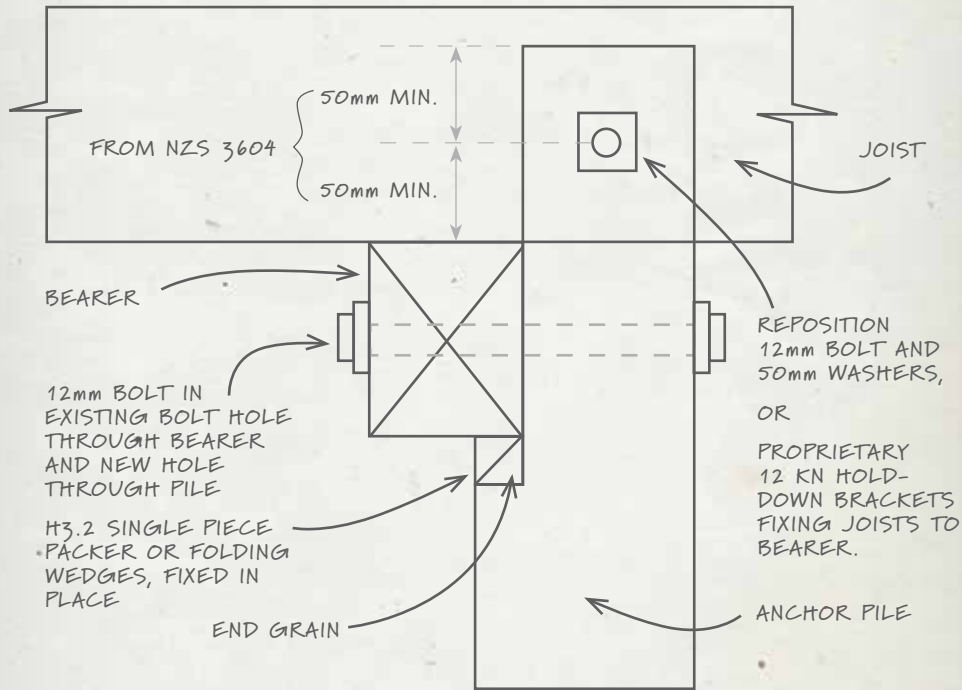
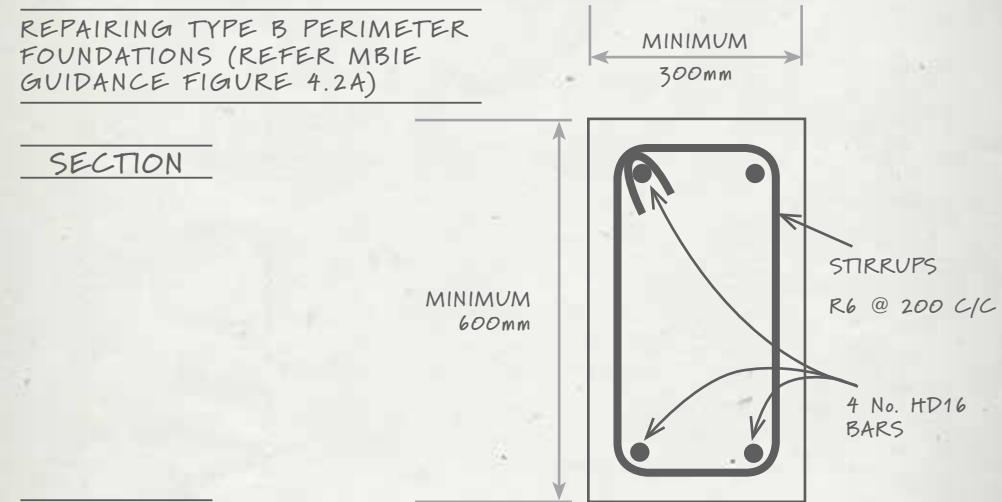
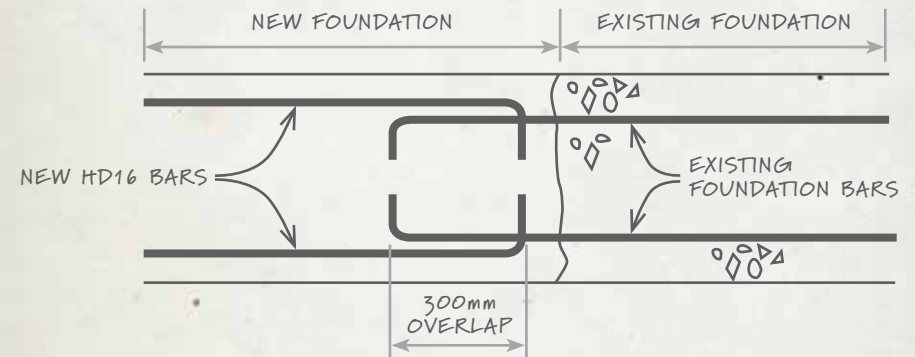

FIGURE: 6

REPAIRING TYPE B PERIMETER FOUNDATIONS (REFER MBIE GUIDANCE FIGURE 4.2A)



ELEVATION



ELEVATION

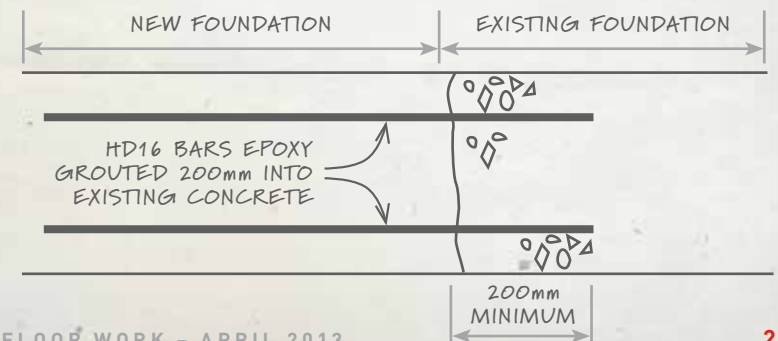

Relevelling Type B foundations: timber floor with piles and perimeter foundation

Here's a checklist of things to consider:

- Check ground bearing capacity to NZS 3604:2011 (conduct test bores to 4 metres where possible)
- Disconnect piped services and power, and loosen flexible cables
- Disconnect pile/bearer connections
- Detach or demolish peripheral attachments such as steps, terraces and decks
- Progressively relevel perimeter foundation or install new foundation sections (see Figure 6)
- For pile/bearer gaps less than 100mm, pack with H3.2 timber (see figures 5A and 5B)
- Inject grout under lifted foundations
- Resettle building and connect bearers and plates to piles and foundations to NZS 3604:2011
- Reconnect services.

Relevelling Type C foundations: Concrete slab-on-ground

Existing concrete slabs that have partly settled or cracked can be jacked back to level, with grout or resin injected beneath the footing and slab.

Here's a checklist of things to consider:

- Check ground bearing capacity to NZS 3604:2011 (conduct test bores to 4 metres where possible)
- Disconnect piped services and power, and loosen flexible cables
- Detach or demolish peripheral attachments such as steps, terraces and decks
- Progressively relevel foundation while injecting flowable grout beneath the slab, or install new foundation sections
- Inject grout under lifted foundations
- Seal exposed cracks (refer *Cracks in concrete floors*)
- Re-lay floor coverings and reconnect services.

Cracks in concrete floors

Most concrete floors will contain some cracks as a result of shrinkage during the concrete's initial curing and hardening. Shrinkage cracks that have not been made worse by the earthquake, will typically not form part of the earthquake repairs.

If cracks are the result of earthquake damage, they can be repaired as follows:

- Cracks less than 1 mm wide: no structural repairs needed, but cracks in reinforced concrete should be sealed where exposed to the weather
- Cracks 1 mm – 10 mm wide: fill with epoxy injection
- Cracks 10 mm – 20 mm wide: fill with grout injection
- Cracks more than 20mm wide: break out slab along the crack and recast the slab section.



See MBIE Guidance Appendix A4 for ways to identify shrinkage cracking and repair cracking, plus information relating to underfloor heating and slab overlays.

Any damage to the damp-proof course should be avoided. If this is punctured, it can be repaired with pressure-sensitive tape.

Installing new underground services

If new underground services are being installed, these should allow for any future ground movements by:

- 'Sleeving' any piped services through foundations and floor slabs – allow a minimum of 60 mm clearance around pipework, and fill with foamed urethane
- Providing flexible connections to piped services outside the foundations
- Providing loops or snaking cables for any cabled services in trenches, to allow for future stretch.

EXAMPLES OF FLEXIBLE CONNECTIONS ARE THE STORM PLASTICS OR PLASTEC RANGE OF PRODUCTS.

PUTTING IN NEW FOUNDATIONS

If the building's existing foundations are so badly damaged they can't be repaired (see *Assessing house foundations*), new foundations will need to be put in.

Acceptable foundation types for each building type will depend on:

- The site's TC and the type of ground under the building
- Floor plan shape
- Wall and roof cladding weights.



For more about the geotechnical investigation needed, see MBIE Guidance Part A, section 3.4 and also Part C, section 13 for TC3. Foundation repairs in TC3 require specific engineering design. For new foundation options, see Part A, section 5.2 for TC1 and TC2, and Part C, section 15 for TC3.



Ground testing

Ground testing will need to be carried out as shown in Figure 7, depending on the site's TC.

FIGURE 7: GROUND TESTING – WHO CAN DO IT

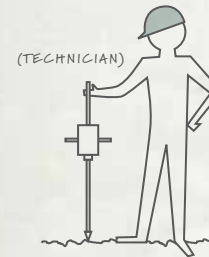

TC1

- TESTING BY A TRAINED TECHNICIAN TO NZS 3604 SECTION 3, INCLUDING TEST BORES AT 3-4m.
- PLUS
- IF TEST SHOWS PEAT - SPECIFIC ENGINEERING DESIGN REQUIRED

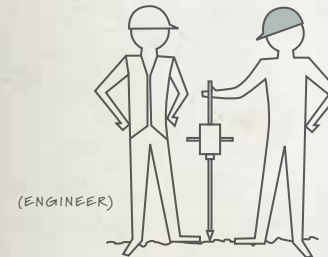

TC2

- TESTING AS FOR TC1
- TESTING BY A TRAINED TECHNICIAN WITH OVERSIGHT BY CPENGA

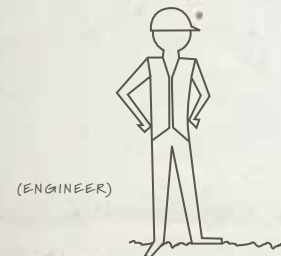

TC3

- DEEP GEOTECHNICAL INVESTIGATION
- BY CPENGA (GEOTECHNICAL ENGINEER)

Ground bearing capacities must be a minimum of:

- 300 kPa for foundations not specifically designed
- 200 kPa for raft foundations (see [MBIE Guidance Part A, section 5.3](#))

OR

- As determined by specific engineering design.

Floor plan shape

Some foundation options depend on simple floor plan shapes. Simple square, rectangular or 'boomerang' floor plans allow easier construction, and possible future releveling of the foundations.

Foundation types that require simple floor plans are:

- Concrete raft foundations (TC2 and TC3)
- Surface structures (TC3).



These are explained further in the Foundation Options Table on page 32 (also see [MBIE Guidance Part A, section 5.3](#) for more about plan shape limitations).

Wall and roof cladding weights

Light or medium weight claddings are recommended for most new building work. This is because light and medium weight claddings place less stress on a building foundation, making the building more resilient (i.e. perform better) in an earthquake.

Heavyweight wall or roof claddings should only be used with some foundation systems, as shown in the following charts.







The [MBIE Guidance Part A, Table 7.2](#) recommends using lightweight or medium-weight claddings for repairs or new construction work wherever possible.

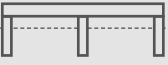
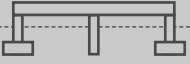
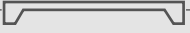

Foundation options

The foundation options based on the site's TC, ground performance and the building's floor plan are summarised in the chart below (including references to the MBIE Guidance). This should be read in conjunction with the next chart on page 34, which sets out maximum cladding weights for the different TC zones and foundation types.

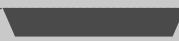
Foundation type (MBIE guidance references)	TC1	TC2	TC3
 <p>Type A: raised timber floor with piles (to NZS 3604:2011 (MBIE Guidance sections 5.1, 5.2, 5.3.2)</p>	Yes	Yes Light and medium-weight claddings	
 <p>Type B: timber floor with piles and perimeter foundation (to NZS 3604: 2011) (MBIE Guidance sections 5.1, 5.2, 5.3.2)</p>	Yes	Yes With enhanced steel reinforcing	
 <p>Type C: concrete slab-on-ground (to NZS 3604:2011 and B1/AS1) (MBIE Guidance sections 5.1, 5.2, 5.3.1)</p>	Yes		

Foundation type (MBIE guidance references)	TC1	TC2	TC3
 <p>Concrete raft foundations (four options) (MBIE Guidance sections 5.3, 5.3.1)</p>	Yes	Yes Simple plan shapes	
 <p>Deep pile foundations (MBIE Guidance section 15.2)</p>	Yes	Yes	Yes Providing there is no global lateral spread
 <p>Site ground improvement (five options) (MBIE Guidance section 15.3)</p>	Generally not needed	Yes	Yes With TC2 foundations (Some restrictions apply)
 <p>Surface structures (three types) (MBIE Guidance section 15.4)</p>			Yes Simple plan shapes (Some restrictions apply)
Specific engineering design	Yes	Yes	Yes

Maximum cladding weights

This table sets out the maximum cladding weights for each foundation type and TC zone (see MBIE Guidance Table 7.2).

Technical Category	Foundation type	Wall cladding Maximum recommended weight		Roof cladding Maximum recommended weight	
		The following maximum cladding weights are default listings only, which may be increased by specific engineering design			
TC1	NZS 3604	Concrete floor	H		H
		Timber floor	Type A	M	H
Type B	H				
TC2	NZS 3604 Type A	M		L	
	NZS 3604 Type B (enhanced)	Single storey M		L	
		Two storey M		L	
	Concrete raft (Simple floor layout)	Options	Single storey		
			1	H	H
			2 (300mm)	H	H
			3	H	H
		4	H	H	
		Two storey			
		1	M	L	
2 (300mm)		M	H		
2 (400mm)		H	H		
3		H	L		
4	M	L			

Technical Category	Foundation type	Wall cladding Maximum recommended weight		Roof cladding Maximum recommended weight
		The following maximum cladding weights are default listings only, which may be increased by specific engineering design		
TC2 / TC3	Hybrid	Timber floor	M	L
		Concrete floor	Single storey	
			H	H
			Two storey	
		M	L	
TC3	Deep Piles	Concrete raft options 2, 4 modified	H	H
	Site Ground Improvement	For use with all TC2 foundation options and cladding weights		
	Surface structures (Simple floor layout)	Type 1, 2	M	L
			Single storey	
		Type 3	M	L
Two storey				
		M	L	

See next page for Key to cladding weights.

Key to cladding weights

Wall claddings:

Light (L) ≤ 30 kg/m ²	(e.g. timber weatherboards)
Medium (M) 30-80 kg/m ²	(e.g. stucco, autoclaved masonry veneer)
Heavy (H) 80-220 kg/m ²	(e.g. masonry veneer)

Roof claddings:

Light (L) ≤ 20 kg/m ²	(e.g. steel roofing or profiled tiles)
Heavy (H) 20-60 kg/m ²	(e.g. masonry tiles)

Ministry of Business, Innovation and Employment (MBIE) – Hikina Whakatutuki
MBIE develops and delivers policy, services, advice and regulation to support economic growth and the prosperity and wellbeing of New Zealanders.
MBIE combines the former Ministries of Economic Development and Science + Innovation, and the Departments of Labour and Building and Housing.

OTHER USEFUL INFORMATION

MBIE's guidance, *Repairing and rebuilding houses affected by the Canterbury earthquakes*, contains detailed information about the topics discussed in this booklet and also repair and rebuilding work to the house's superstructure. See www.dbh.govt.nz/guidance-on-repairs-after-earthquake

Other useful sections in the MBIE Guidance include:

- Releveling systems and outline methods (MBIE Guidance Part A Appendix A1)
- Insurance and regulatory requirements (MBIE Guidance Part B section 8).

The companion to this booklet, *Above-Floor Work*, is also based on the MBIE Guidance.

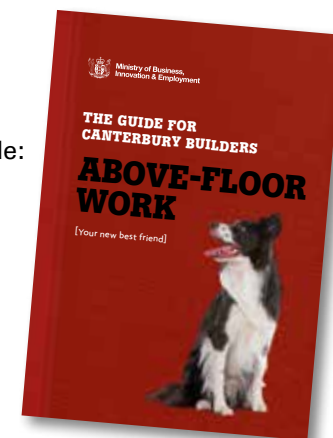

Other relevant publications and links include:

- Lifting Earthquake Affected Buildings in Christchurch – www.dol.govt.nz/quake/lifting-earthquake-affected-buildings-christchurch.pdf
- Subdivision investigation requirements – www.dbh.govt.nz/subdivisions-assessment-guide
- Ductile reinforcing in slabs – www.dbh.govt.nz/seismicity-info
- Guidance on garage classification – www.dbh.govt.nz/codewords-35-1
- "Repair approaches" – BRANZ Bulletin 548 – search at www.branz.co.nz
- Asbestos management – www.dol.govt.nz/quake/asbestos-management.pdf
- Building consent exemptions – www.ccc.govt.nz/homeliving/buildingplanning/buildingconsents/exemption.aspx



Published in April 2013
by Ministry of Business, Innovation and Employment, PO Box 10-729,
Wellington, New Zealand.

This document is issued as guidance under section 175 of the Building Act 2004. While the Ministry has taken care in preparing the document, it should not be relied upon as establishing compliance with all relevant clauses of the Building Act or Building Code in all cases that may arise. The document may be updated from time to time and the latest version is available from the Ministry's website at www.dbh.govt.nz.

ISBN [978-0-478-39938-7] (Print) ISBN [978-0-478-39939-4] (Online)

New Zealand Government