



**C/AS2**

# Acceptable Solution for Buildings other than Risk Group SH

For New Zealand Building Code Clauses C1-C6  
Protection from Fire



## Status of Verification Methods and Acceptable Solutions

Verification Methods and Acceptable Solutions are prepared by the Ministry of Business, Innovation and Employment in accordance with section 22 of the Building Act 2004. Verification Methods and Acceptable Solutions are for use in establishing compliance with the New Zealand Building Code.

A person who complies with a Verification Method or Acceptable Solution will be treated as having complied with the provisions of the Building Code to which the Verification Method or Acceptable Solution relates. However, using a Verification Method or Acceptable Solution is only one method of complying with the Building Code. There may be alternative ways to comply.

Defined words (italicised in the text) and classified uses are explained in Clauses A1 and A2 of the Building Code and in the Definitions at the start of this document.

Enquiries about the content of this document should be directed to:



**MINISTRY OF BUSINESS,  
INNOVATION & EMPLOYMENT**  
HĪKINA WHAKATUTUKI

Ministry of Business, Innovation and Employment  
PO Box 1473, Wellington.6140  
Telephone 0800 242 243  
Email: [info@building.govt.nz](mailto:info@building.govt.nz)

**Verification Methods and Acceptable Solutions  
are available from [www.building.govt.nz](http://www.building.govt.nz)**

## New Zealand Government

ISBN (online) 978-1-98-857008-2

© Ministry of Business, Innovation and Employment 2020

This document is protected by Crown copyright, unless indicated otherwise. The Ministry of Business, Innovation and Employment administers the copyright in this document. You may use and reproduce this document for your personal use or for the purposes of your business provided you reproduce the document accurately and not in an inappropriate or misleading context. You may not distribute this document to others or reproduce it for sale or profit.

The Ministry of Business, Innovation and Employment owns or has licences to use all images and trademarks in this document. You must not use or reproduce images and trademarks featured in this document for any purpose (except as part of an accurate reproduction of this document) unless you first obtain the written permission of the Ministry of Business, Innovation and Employment.

## Document status

The most recent version of this document (Amendment 2), as detailed in the Document History, is approved by the Chief Executive of the Ministry of Business, Innovation and Employment. It is effective from 5 November 2020 and supersedes all previous versions.

The previous edition of this Acceptable Solution C/AS2, as amended, will cease to have effect on 3 November 2021.

People using this document should check for amendments on a regular basis. The Ministry of Business, Innovation and Employment may amend any part of any Acceptable Solution or Verification Method at any time. Up-to-date versions of Acceptable Solutions and Verification Methods are available from [www.building.govt.nz](http://www.building.govt.nz)

C: Document History			
	Date	Alterations	
First edition	27 June 2019		
Amendment 1 (Errata 1)	Effective from 22 October 2019 until 3 November 2021	p. 34, Table 1.1 p. 43, Table 2.2b p. 44, Table 2.2c	
Amendment 2	5 November 2020	p. 18 Contents pp. 19-21 References pp. 22-24, 26-27, 30-32 Definitions pp. 34, 36 Part 1 pp. 41, 48 Part 2	pp. 50, 57-58, 64-79, 82-87 Part 3 pp. 89-90, 95-100, 105, 108-118, Part 4 pp. 121-124, 128-136, 139-143 Part 5 pp. 146-147 Part 7 pp. 155, 158 Appendix C

**C1—OBJECTIVES OF CLAUSES C2  
TO C6 (PROTECTION FROM FIRE)****Provisions**

The objectives of clauses C2 to C6 are to:

- (a) safeguard people from an unacceptable risk of injury or illness caused by *fire*,
- (b) protect *other property* from damage caused by *fire*, and
- (c) facilitate firefighting and rescue operations.

**Limit on application**

**C2—PREVENTION OF FIRE  
OCCURRING****Provisions****FUNCTIONAL REQUIREMENT**

**C2.1** Fixed appliances using controlled combustion and other fixed equipment must be designed, constructed, and installed in *buildings* in a way that reduces the likelihood of illness or injury due to *fire* occurring.

**PERFORMANCE**

**C2.2** The maximum surface temperature of *combustible building materials* close to fixed appliances using controlled combustion and other fixed equipment when operating at their design level must not exceed 90°C.

**C2.3** Fixed appliances using controlled combustion and other fixed equipment must be designed, constructed and installed so that there is a low probability of explosive or hazardous conditions occurring within any spaces in or around the *building* that contains the appliances.

**Limit on application**

**C3—FIRE AFFECTING AREAS BEYOND THE FIRE SOURCE****Provisions****FUNCTIONAL REQUIREMENT**

**C3.1** *Buildings* must be designed and constructed so that there is a low probability of injury or illness to persons not in close proximity to a *fire source*.

**C3.2** *Buildings* with a *building height* greater than 10 m where upper floors contain sleeping uses or *other property* must be designed and constructed so that there is a low probability of external vertical fire spread to upper floors in the *building*.

**C3.3** *Buildings* must be designed and constructed so that there is a low probability of *fire* spread to *other property* vertically or horizontally across a *relevant boundary*.

**Limit on application**

Clause C3.2 does not apply to importance level 1 *buildings*.

**C3—FIRE AFFECTING AREAS BEYOND THE FIRE SOURCE** (continued)

**Provisions**

**PERFORMANCE**

**C3.4** (a) materials used as internal surface linings in the following areas of *buildings* must meet the performance criteria specified below:

**Limit on application**

Clause C3.4 does not apply to *detached dwellings*, within *household units* in *multi-unit dwellings*, or *outbuildings* and *ancillary buildings*.

Area of <i>building</i>	Performance determined under conditions described in ISO 9705: 1993	
	<i>Buildings not protected with an automatic fire sprinkler system</i>	<i>Buildings protected with an automatic fire sprinkler system</i>
Wall/ceiling materials in sleeping areas where care or detention is provided	Material Group Number 1-S	Material Group Number 1 or 2
Wall/ceiling materials in exitways	Material Group Number 1-S	Material Group Number 1 or 2
Wall/ceiling materials in all <i>occupied spaces</i> in importance level 4 <i>buildings</i>	Material Group Number 1-S	Material Group Number 1 or 2
Internal surfaces of ducts for <i>HVAC systems</i>	Material Group Number 1-S	Material Group Number 1 or 2
Ceiling materials in crowd and sleeping uses except <i>household units</i> and where care or detention is provided	Material Group Number 1-S or 2-S	Material Group Number 1 or 2
Wall materials in crowd and sleeping uses except <i>household units</i> and where care or detention is provided	Material Group Number 1-S or 2-S	Material Group Number 1, 2, or 3
Wall/ceiling materials in occupied spaces in all other locations in <i>buildings</i> , including <i>household units</i>	Material Group Number 1, 2, or 3	Material Group Number 1, 2, or 3
External surfaces of ducts for <i>HVAC systems</i>	Material Group Number 1, 2, or 3	Material Group Number 1, 2, or 3
Acoustic treatment and pipe insulation within airhandling plenums in sleeping uses	Material Group Number 1, 2, or 3	Material Group Number 1, 2, or 3

**C3—FIRE AFFECTING AREAS BEYOND THE FIRE SOURCE** (continued)**Provisions**

(b) floor surface materials in the following areas of *buildings* must meet the performance criteria specified below:

**Limit on application**

Area of <i>building</i>	Minimum critical radiant flux when tested to ISO 9239-1: 2010	
	<i>Buildings not protected with an automatic fire sprinkler system</i>	<i>Buildings protected with an automatic fire sprinkler system</i>
Sleeping areas and exitways in <i>buildings</i> where care or detention is provided	4.5 kW/m <sup>2</sup>	2.2 kW/m <sup>2</sup>
Exitways in all other <i>buildings</i>	2.2 kW/m <sup>2</sup>	2.2 kW/m <sup>2</sup>
<i>Firecells</i> accommodating more than 50 persons	2.2 kW/m <sup>2</sup>	1.2 kW/m <sup>2</sup>
All other occupied spaces except <i>household units</i>	1.2 kW/m <sup>2</sup>	1.2 kW/m <sup>2</sup>

(c) suspended flexible fabrics and membrane structures used in the construction of *buildings* must have properties resulting in a low probability of injury or illness to persons not in close proximity to a *fire source*.

**C3.5** *Buildings* must be designed and constructed so that fire does not spread more than 3.5 m vertically from the *fire source* over the external cladding of multi-level *buildings*.

**C3.6** *Buildings* must be designed and constructed so that in the event of *fire* in the building the received radiation at the *relevant boundary* of the property does not exceed 30 kW/m<sup>2</sup> and at a distance of 1 m beyond the relevant boundary of the property does not exceed 16 kW/m<sup>2</sup>.



### C3—FIRE AFFECTING AREAS BEYOND THE FIRE SOURCE (continued)

#### Provisions

**C3.7** External walls of *buildings* that are located closer than 1 m to the *relevant boundary* of the property on which the *building* stands must either:

- (a) be constructed from materials which are not *combustible building materials*, or
- (b) for *buildings* in importance levels 3 and 4, be constructed from materials that, when subjected to a radiant flux of 30 kW/m<sup>2</sup>, do not ignite for 30 minutes, or
- (c) for *buildings* in Importance Levels 1 and 2, be constructed from materials that, when subjected to a radiant flux of 30 kW/m<sup>2</sup>, do not ignite for 15 minutes.

**C3.8** *Firecells* located within 15 m of a *relevant boundary* that are not protected by an automatic *fire* sprinkler system, and that contain a *fire load* greater than 20 TJ or that have a floor area greater than 5,000 m<sup>2</sup> must be designed and constructed so that at the time that firefighters first apply water to the *fire*, the maximum radiation flux at 1.5 m above the floor is no greater than 4.5 kW/m<sup>2</sup> and the smoke layer is not less than 2 m above the floor.

**C3.9** *Buildings* must be designed and constructed with regard to the likelihood and consequence of failure of any *fire safety* system intended to control *fire* spread.

#### Limit on application

**C4—MOVEMENT TO PLACE OF SAFETY****Provisions****FUNCTIONAL REQUIREMENT**

**C4.1** *Buildings* must be provided with:

- (a) effective means of giving warning of *fire*, and
- (b) visibility in *escape routes* complying with clause F6.

**C4.2** *Buildings* must be provided with means of escape to ensure that there is a low probability of occupants of those buildings being unreasonably delayed or impeded from moving to a *place of safety* and that those occupants will not suffer injury or illness as a result.

**PERFORMANCE**

**C4.3** The *evacuation time* must allow occupants of a building to move to a *place of safety* in the event of a fire so that occupants are not exposed to any of the following:

- (a) a *fractional effective dose* of carbon monoxide greater than 0.3:
- (b) a *fractional effective dose* of thermal effects greater than 0.3:
- (c) conditions where, due to smoke obscuration, visibility is less than 10 m except in rooms of less than 100 m<sup>2</sup> where visibility may fall to 5 m.

**C4.4** Clause C4.3(b) and (c) do not apply where it is not possible to expose more than 1 000 occupants in a *firecell* protected with an automatic *fire* sprinkler system.

**C4.5** Means of escape to a *place of safety* in *buildings* must be designed and constructed with regard to the likelihood and consequence of failure of any *fire safety systems*.

**Limit on application**

## C5—ACCESS AND SAFETY FOR FIREFIGHTING OPERATIONS

### Provisions

#### FUNCTIONAL REQUIREMENT

**C5.1** *Buildings* must be designed and constructed so that there is a low probability of firefighters or other emergency services personnel being delayed in or impeded from assisting in rescue operations and performing firefighting operations.

**C5.2** *Buildings* must be designed and constructed so that there is a low probability of illness or injury to firefighters or other emergency services personnel during rescue and firefighting operations.

#### PERFORMANCE

**C5.3** *Buildings* must be provided with access for fire service vehicles to a hard-standing from which there is an unobstructed path to the *building* within 20 m of:

- (a) the firefighter access into the *building*, and
- (b) the inlets to automatic fire sprinkler systems or fire hydrant systems, where these are installed.

**C5.4** Access for fire service vehicles in accordance with clause C5.3 must be provided to more than 1 side of *firecells* greater than 5,000 m<sup>2</sup> in floor area that are not protected by an automatic fire sprinkler system.

**C5.5** *Buildings* must be provided with the means to deliver water for firefighting to all parts of the *building*.

**C5.6** *Buildings* must be designed and constructed in a manner that will allow firefighters, taking into account the firefighters' personal protective equipment and standard training, to:

- (a) reach the floor of fire origin,
- (b) search the general area of fire origin, and
- (c) protect their means of egress.

### Limit on application

Performance requirements in clauses C5.3 to C5.8 do not apply to *backcountry huts*, *detached dwellings*, within *household units* in *multi-unit dwellings*, or to *outbuildings*, and *ancillary buildings*.

**C5—ACCESS AND SAFETY FOR  
FIREFIGHTING OPERATIONS** (continued)**Provisions**

**C5.7** *Buildings* must be provided with means of giving clear information to enable firefighters to:

- (a) establish the general location of the *fire*,
- (b) identify the *fire safety systems* available in the *building*, and
- (c) establish the presence of *hazardous substances* or process in the *building*.

**C5.8** Means to provide access for and safety of firefighters in *buildings* must be designed and constructed with regard to the likelihood and consequence of failure of any *fire safety systems*.

**Limit on application**

C6—STRUCTURAL STABILITY	Limit on application
<p data-bbox="507 566 639 593" style="text-align: center;"><b>Provisions</b></p> <p data-bbox="325 607 691 633"><b>FUNCTIONAL REQUIREMENT</b></p> <p data-bbox="325 647 804 725"><b>C6.1</b> Structural systems in <i>buildings</i> must be constructed to maintain structural stability during <i>fire</i> so that there is:</p> <ul style="list-style-type: none"> <li data-bbox="325 739 778 797">(a) a low probability of injury or illness to occupants,</li> <li data-bbox="325 810 783 889">(b) a low probability of injury or illness to <i>fire</i> service personnel during rescue and firefighting operations, and</li> <li data-bbox="325 902 719 981">(c) a low probability of direct or consequential damage to adjacent <i>household units</i> or <i>other property</i>.</li> </ul> <p data-bbox="325 994 528 1021"><b>PERFORMANCE</b></p> <p data-bbox="325 1034 804 1196"><b>C6.2</b> Structural systems in <i>buildings</i> that are necessary for structural stability in <i>fire</i> must be designed and constructed so that they remain stable during <i>fire</i> and after <i>fire</i> when required to protect <i>other property</i> taking into account:</p> <ul style="list-style-type: none"> <li data-bbox="325 1209 549 1236">(a) the <i>fire</i> severity,</li> <li data-bbox="325 1249 775 1308">(b) any automatic fire sprinkler systems within the <i>buildings</i>,</li> <li data-bbox="325 1321 815 1400">(c) any other active <i>fire safety systems</i> that affect the <i>fire</i> severity and its impact on structural stability, and</li> <li data-bbox="325 1413 812 1518">(d) the likelihood and consequence of failure of any <i>fire safety systems</i> that affect the <i>fire</i> severity and its impact on structural stability.</li> </ul> <p data-bbox="325 1532 791 1722"><b>C6.3</b> Structural systems in <i>buildings</i> that are necessary to provide firefighters with safe access to floors for the purpose of conducting firefighting and rescue operations must be designed and constructed so that they remain stable during and after <i>fire</i>.</p> <p data-bbox="325 1736 804 1865"><b>C6.4</b> Collapse of building elements that have lesser <i>fire</i> resistance must not cause the consequential collapse of elements that are required to have a higher <i>fire</i> resistance.</p>	

**CLAUSE A3—BUILDING IMPORTANCE LEVELS**

For the purposes of clause C, a *building* has one of the importance levels set out below:

Importance level	Description of building type	Specific structure
Importance level 1	<i>Buildings</i> posing low risk to human life or the environment, or a low economic cost, should the <i>building</i> fail. These are typically small non-habitable <i>buildings</i> , such as sheds, barns, and the like, that are not normally occupied, though they may have occupants from time to time.	<ul style="list-style-type: none"> <li>• Ancillary <i>buildings</i> not for human habitation</li> <li>• Minor storage facilities</li> <li>• Backcountry huts</li> </ul>
Importance level 2	<i>Buildings</i> posing normal risk to human life or the environment, or a normal economic cost, should the <i>building</i> fail. These are typical residential, commercial, and industrial <i>buildings</i> .	<ul style="list-style-type: none"> <li>• All <i>buildings</i> and facilities except those listed in importance levels 1, 3, 4, and 5</li> </ul>
Importance level 3	<i>Buildings</i> of a higher level of societal benefit or importance, or with higher levels of risk-significant factors to <i>building</i> occupants. These <i>buildings</i> have increased performance requirements because they may house large numbers of people, vulnerable populations, or occupants with other risk factors, or fulfil a role of increased importance to the local community or to society in general.	<ul style="list-style-type: none"> <li>• <i>Buildings</i> where more than 300 people congregate in 1 area</li> <li>• <i>Buildings</i> with primary school, secondary school, or daycare facilities with a capacity greater than 250</li> <li>• <i>Buildings</i> with tertiary or adult education facilities with a capacity greater than 500</li> <li>• Health care facilities with a capacity of 50 or more residents but not having surgery or emergency treatment facilities</li> <li>• Jails and detention facilities</li> <li>• Any other <i>building</i> with a capacity of 5 000 or more people</li> <li>• <i>Buildings</i> for power generating facilities, water treatment for potable water, wastewater treatment facilities, and other public utilities facilities not included in importance level 4</li> </ul>

**CLAUSE A3—BUILDING IMPORTANCE LEVELS** (continued)

Importance level	Description of building type	Specific structure
Importance level 3 (continued)		<ul style="list-style-type: none"> <li>• <i>Buildings</i> not included in importance level 4 or 5 containing sufficient quantities of highly toxic gas or explosive materials capable of causing acutely hazardous conditions that do not extend beyond property boundaries</li> </ul>
Importance level 4	<p><i>Buildings</i> that are essential to post-disaster recovery or associated with hazardous facilities.</p>	<ul style="list-style-type: none"> <li>• Hospitals and other health care facilities having surgery or emergency treatment facilities</li> <li>• <i>Fire</i>, rescue, and police stations and emergency vehicle garages</li> <li>• <i>Buildings</i> intended to be used as emergency shelters</li> <li>• <i>Buildings</i> intended by the owner to contribute to emergency preparedness, or to be used for communication, and operation centres in an emergency, and other facilities required for emergency response</li> <li>• Power generating stations and other utilities required as emergency backup facilities for importance level 3 structures</li> <li>• <i>Buildings</i> housing highly toxic gas or explosive materials capable of causing acutely hazardous conditions that extend beyond property boundaries</li> <li>• Aviation control towers, air traffic control centres, and emergency aircraft hangars</li> <li>• <i>Buildings</i> having critical national defence functions</li> <li>• Water treatment facilities required to maintain water pressure for fire suppression</li> </ul>

**CLAUSE A3—BUILDING IMPORTANCE LEVELS** (continued)

Importance level	Description of building type	Specific structure
Importance level 4 (continued)		<ul style="list-style-type: none"> <li>Ancillary <i>buildings</i> (including, but not limited to, communication towers, fuel storage tanks or other structures housing or supporting water or other <i>fire</i> suppression material or equipment) required for operation of importance level 4 structures during an emergency</li> </ul>
Importance level 5	<i>Buildings</i> whose failure poses catastrophic risk to a large area (eg, 100 km <sup>2</sup> ) or a large number of people (eg, 100 000).	<ul style="list-style-type: none"> <li>Major dams</li> <li>Extremely hazardous facilities</li> </ul>



# Contents

---

## References 19

---

## Definitions 22

---

## Part 1: General 33

---

- 1.1 Introduction and scope .....33
- 1.2 Using this Acceptable Solution ..... 36
- 1.3 Alterations to buildings ..... 36
- 1.4 Calculating occupant loads .....37

---

## Part 2: Firecells, fire safety systems and fire resistance ratings 40

---

- 2.1 Provision of firecells ..... 40
- 2.2 Fire safety systems ..... 41
- 2.3 Fire resistance ratings.....47

---

## Part 3: Means of escape 50

---

- 3.1 General principles ..... 50
- 3.2 Number of escape routes ..... 50
- 3.3 Height and width of escape routes ....53
- 3.4 Length of escape routes ..... 58
- 3.5 Escape from basements..... 66
- 3.6 Open paths..... 66
- 3.7 Special cases of open paths .....67
- 3.8 Dead ends.....72
- 3.9 Exitways.....72
- 3.10 Control of exitway activities ..... 74
- 3.11 External escape routes .....76
- 3.12 Final exits.....79
- 3.13 Single escape routes .....79
- 3.14 Special conditions for safe paths ..... 82
- 3.15 Doors subdividing escape routes..... 82
- 3.16 Signs .....87

---

## Part 4: Control of internal fire and smoke spread 88

---

- 4.1 Firecells ..... 88
- 4.2 Glazing in fire and smoke separations 90
- 4.3 Structural stability during fire ..... 90
- 4.4 Fire stopping ..... 92
- 4.5 Firecell construction ..... 92
- 4.6 Specific requirements for sleeping areas ..... 95
- 4.7 Specific requirements for theatres, exhibition areas and retail spaces..... 98
- 4.8 Tiered seating in risk group CA ..... 98
- 4.9 Exitways..... 99
- 4.10 Intermittent activities.....100
- 4.11 Protected shafts ..... 102
- 4.12 Long corridor subdivision ..... 103
- 4.13 Floors ..... 103
- 4.14 Subfloor spaces.....104
- 4.15 Concealed spaces ..... 107
- 4.16 Closures in fire and smoke separations .....110
- 4.17 Interior surface finishes, floor coverings and suspended flexible fabrics .....116
- 4.18 Building services plant.....118

---

## Part 5: Control of external fire spread 120

---

- 5.1 Fire separation for buildings with more than one title..... 120
- 5.2 Horizontal fire spread from external walls ..... 120
- 5.3 FRRs of external walls ..... 121
- 5.4 Small openings and fire resisting glazing..... 121
- 5.5 Table method for external walls..... 122
- 5.6 Horizontal fire spread from roofs and open sided buildings ..... 136
- 5.7 Vertical fire spread ..... 138
- 5.8 External cladding systems ..... 143

---

**Part 6: Firefighting 144**

---

- 6.1 Fire and Emergency New Zealand  
vehicular access ..... 144
- 6.2 Information for firefighters ..... 144
- 6.3 Firefighting facilities..... 145

---

**Part 7: Prevention of fire  
occurring 146**

---

- 7.1 Solid fuel appliances ..... 146
- 7.2 Gas-burning appliances ..... 146
- 7.3 Oil-fired appliances ..... 147
- 7.4 Electrical fire safety ..... 147
- 7.5 Open fires ..... 148

Amend 2  
Nov 2020

---

**Appendix A (normative):  
Fire safety systems 153**

---

---

**Appendix B (normative):  
Fire sprinkler systems 154**

---

---

**Appendix C (normative):  
Test methods 155**

---

## References

For the purposes of New Zealand Building Code compliance, the New Zealand and other Standards, and other documents referred to in this Acceptable Solution (primary reference documents) shall be the editions, along with their specific amendments, listed below. Where the primary reference documents refer to other Standards or other documents (secondary reference documents), which in turn may also refer to other Standards or other documents, and so on (lower order reference documents), then the applicable version of these secondary and lower order reference documents shall be the version in effect at the date that the primary reference document was published.

		Where quoted
<b>Standards New Zealand</b>		
NZS/BS 476:-	Fire tests on building materials and structures	
Part 21:1987	Methods for determination of the fire resistance of loadbearing elements of construction	C5.1.1
Part 22:1987	Methods for determination of the fire resistance of non-loadbearing elements of construction	C5.1.1
AS/NZS 1668:-	The use of ventilation and air conditioning in buildings	
Part 1: 1998	Fire and smoke control in multi-compartment buildings <i>Amend: 1</i>	3.10.4, 3.10.5, A2.1.1, Table 2.2
AS/NZS 2918: 2001	Domestic solid fuel burning appliances – installation	7.1.1, 7.1.2, 7.3.3, 7.5.5, 7.5.12
AS/NZS 3837: 1998	Method of test for heat and smoke release rates for materials and properties using an oxygen consumption calorimeter <i>Amend: 1</i>	C7.1.1
NZS 4232:-	Performance criteria for fire resisting closures	
Part 2: 1988	Fire resisting glazing systems	Definitions
NZS 4332: 1997	Non-domestic passenger and goods lifts	6.3.3, Table 2.2
NZS 4510: 2008	Fire hydrant systems for buildings <i>Amend: 1</i>	6.3.2, A2.1.1, Table 2.2
NZS 4512: 2010	Fire detection and alarm systems in buildings	2.2.2, 4.15.6, 6.2.1, A2.1.1, C6.1.6, Table 2.2
NZS 4515: 2009	Fire sprinkler systems for life safety in sleeping occupancies (up to 2000 m <sup>2</sup> )	Definitions, 2.3.13, 6.2.1, B3.1.1, Tables 2.2 and 2.2a
NZS 4520: 2010	Fire resistant doorsets	4.2.4, 4.16.6, C6.1.1
NZS 4541: 2013	Automatic fire sprinkler systems	Definitions, 2.3.13, 5.2.2, 6.2.1, B2.1.1, Tables 2.2 and 2.2a

Amend 2  
Nov 2020

Amend 2  
Nov 2020

	Where quoted
<b>Standards Australia</b>	
AS 1366:- Rigid cellular plastics sheets for thermal insulation	
Part 1: 1992 Rigid cellular polyurethane (RC/PUR) <i>Amend: 1</i>	4.17.2
Part 2: 1992 Rigid cellular polyisocyanurate (RC/PIR)	4.17.2
Part 3: 1992 Rigid cellular polystyrene – moulded (RC/PS-M) <i>Amend: 1</i>	4.17.2
Part 4: 1989 Rigid cellular polystyrene – extruded (RC/PS-E)	4.17.2
AS 1530:- Methods for fire tests on building materials, components and structures	
Part 1: 1994 Combustibility test for materials	Definitions, C4.1.1
Part 2: 1993 Test for flammability of materials	4.17.8, 4.17.9, C3.1
Part 4: 2005 Fire-resistance tests of elements of building construction	4.5.9, C5.1.1
AS 1682:- Fire Dampers	
Part 1: 1990 Specification	4.16.12, 4.16.14
Part 2: 1990 Installation	4.16.12, 4.16.14
AS 1691: 1985 Domestic oil-fired appliances – installation	7.3.1, 7.3.2
AS 4072:- Components for the protection of openings in fire-resistant separating elements	
Part 1: 2005 Service penetrations and control joints <i>Amend: 1</i>	C5.1.2
AS 4254:- Ductwork for air-handling systems in buildings	
Part 1: 2012 Flexible duct	Table 4.4
Part 2: 2012 Rigid duct	Table 4.4
AS 5113: 2016 Classification of external walls of buildings based on reaction-to-fire performance <i>Amend: 1</i>	5.8.3
AS ISO 9705: 2003 Fire tests – Full scale room test for surface products	Table C1.1
<b>International Standards Organisation</b>	
ISO 5660:- Reaction-to-fire tests – Heat release, smoke production and mass loss rate	
Part 1: 2002 Heat release rate (cone calorimeter method)	C4.1.2, C7.1.1, C7.1.2, Table C1.1
Part 2: 2002 Smoke production rate (dynamic measurement)	C4.1.2, Table C1.1

Amend 2  
Nov 2020Amend 2  
Nov 2020

		Where quoted
	ISO 9239:- Part 1: 2010	Reaction to fire tests for flooring Determination of the burning behaviour using a radiant heat source
	ISO 9705: 1993	Fire tests – Full scale room test for surface products
	<b>British Standards Institution</b>	
	BS 8414:- Part 1: 2015	Fire performance of external cladding systems Test method for non-loadbearing external cladding systems applied to the masonry face of a building <i>Amend: 1 (2017)</i>
	Part 2: 2017	Test method for non-loadbearing external cladding systems fixed to and supported by a structural steel frame <i>Amend: 1 (2017)</i>
Amend 2 Nov 2020	BS EN 12101:- Part 1: 2005	Smoke and heat control systems Specification for smoke barriers
	BS EN 13501:- Part 1: 2018	Fire classification of construction products and building elements Classification using test data from reaction to fire tests
Amend 2 Nov 2020	<b>National Fire Protection Association</b>	
	NFPA 285: 2019	Standard fire test method for evaluation of fire propagation characteristics of exterior wall assemblies containing combustible components
Amend 2 Nov 2020	<b>American Society for Testing and Materials</b>	
	ASTM D 2898: 2010	Standard practice for accelerated weathering of fire-retardant-treated wood for fire testing
	<b>BRE Global</b>	
	BRE 135: 2013	Fire performance of external thermal insulation for walls of multi-storey buildings – Third Edition
Amend 2 Nov 2020	<b>New Zealand Legislation</b>	
	Education (Early Childhood Services) Regulations 2008	Table 1.2
	Hazardous Substances and New Organisms Act 1996	Definitions, 1.1.6
	Health and Safety at Work (Hazardous Substances) Regulations 2017	1.1.6
	<b>Australian Building Codes Board</b>	
	National Construction Code (NCC) 2015	Table C1.1

## Definitions

Access route	A continuous route that permits people and goods to move between the apron or <i>construction</i> edge of the <i>building</i> to spaces within a <i>building</i> , and between spaces within a <i>building</i> .
Accessible	Having features to permit use by <i>people with disabilities</i> .
Accessible route	An <i>access route</i> usable by <i>people with disabilities</i> . It shall be a continuous route that can be negotiated unaided by a wheelchair user. The route shall extend from street <i>boundary</i> or car parking area to those spaces within the <i>building</i> required to be <i>accessible</i> to enable <i>people with disabilities</i> to carry out normal activities and processes within the <i>building</i> .
Adjacent building	A nearby <i>building</i> , including an adjoining <i>building</i> , whether or not erected on <i>other property</i> .
Allotment	Has the meaning given to it by section 10 of the Building Act 2004.
Amend 2 Nov 2020   Backcountry hut	<p>A <i>building</i> that—</p> <ol style="list-style-type: none"> <li>a) is located on land that is administered by the Department of Conservation for conservation, recreational, scientific, or other related purposes, including any land administered under any of the following: <ol style="list-style-type: none"> <li>i) the Conservation Act 1987;</li> <li>ii) the National Parks Act 1980;</li> <li>iii) the Reserves Act 1977; and</li> </ol> </li> <li>b) is intended to provide overnight shelter to any person who may visit and who carries his or her own food, bedding, clothing, and outdoor equipment; and</li> <li>c) contains only basic facilities, which may include (but are not limited to) any or all of the following: <ol style="list-style-type: none"> <li>i) sleeping platforms or bunks;</li> <li>ii) mattresses;</li> <li>iii) food preparation surfaces;</li> <li>iv) appliances for heating;</li> <li>v) appliances for cooking;</li> <li>vi) toilets; and</li> </ol> </li> <li>d) has been certified by the Director-General as being in a location that wheelchair users are unlikely to be able to visit; and</li> <li>e) is intended to be able to sleep— <ol style="list-style-type: none"> <li>i) no more than 20 people in its backcountry hut sleeping area; and</li> <li>ii) no more than 40 people in total; and</li> </ol> </li> <li>f) does not contain any connection, except by radiocommunications, to a network utility operator.</li> </ol>
Basement	Any <i>firecell</i> or part of a <i>firecell</i> below the level of the lowest <i>final exit</i> .
Boundary	Any <i>boundary</i> that is shown on a survey plan that is approved by the Surveyor-General and deposited with the Registrar-General of Land, whether or not a new title has been issued.

Building	Has the meaning given to it by sections 8 and 9 of the <i>Building Act 2004</i> . For the purposes of this Acceptable Solution and notwithstanding the definition of <i>building</i> , a number of separated <i>buildings</i> cannot be taken as a single <i>firecell</i> .
Building Act 2004 (the Building Act)	The principal legislation dealing with <i>building</i> controls in New Zealand.
Building Code	The regulations made under section 400 of the <i>Building Act 2004</i> .
Building consent	Means a consent to carry out <i>building</i> work granted by a <i>building consent authority</i> under section 49 of the <i>Building Act 2004</i> .
Building consent authority	Has the meaning ascribed to it by section 7 of the <i>Building Act 2004</i> .
Building element	Any structural and non-structural component or assembly incorporated into or associated with a <i>building</i> . Included are <i>fixtures</i> , services, drains, permanent mechanical installations for access, glazing, partitions, ceilings and temporary supports.
Building height	The vertical distance between the floor level of the lowest <i>occupied space</i> above the ground and the top of the highest occupied floor, but not including spaces located within or on the roof that enclose stairways, lift shafts, or machinery rooms.
Cavity barrier	A <i>construction</i> provided to close openings within a <i>concealed space</i> against the passage of <i>fire</i> , or to restrict the spread of <i>fire</i> within such spaces.
Chimney	A <i>non-combustible</i> structure which encloses one or more <i>flues</i> , <i>fireplaces</i> or other heating appliances.
Chimney back	The <i>non-combustible</i> wall forming the back of a <i>fireplace</i> .
Chimney breast	The front <i>fireplace</i> wall <i>construction</i> above the <i>fireplace</i> opening.
Chimney jambs	The side walls of a <i>fireplace</i> .
Combustible	See <i>non-combustible</i> .
Communal service functions	Spaces that provide day to day service function to support the sleeping areas and are higher <i>fire</i> risk than <i>direct support functions</i> . These are generally enclosed spaces which include but are not limited to offices, waiting rooms, lounges, stores, dining rooms, laundries and kitchens.
Concealed space	Any part of the space within a <i>building</i> , excluding <i>protected shafts</i> , that cannot be seen from an <i>occupied space</i> .
Construct	In relation to a <i>building</i> , includes to design, build, erect, prefabricate, and relocate the <i>building</i> ; and construction has a corresponding meaning.
Damp-proof course	A strip of durable vapour barrier placed between <i>building elements</i> to prevent the passage of moisture from one element to another.
Damper blade	A component of a <i>fire damper</i> that closes off the airway within a <i>fire damper</i> upon detection of <i>fire</i> or smoke.

Amend 2  
Nov 2020Amend 2  
Nov 2020

Amend 2  
Nov 2020Amend 2  
Nov 2020

Dead end	That part of an <i>open path</i> where escape is possible in only one direction.
Direct support function	Activities that provide support to the primary use of a space that are open areas of low risk and <i>fire load</i> which may include but are not limited to reception desks, nurses stations, kiosks, tea bays, sanitary facilities and mail boxes (sanitary facilities may be enclosed to provide appropriate privacy).
Doorset	A complete assembly comprising a door leaf or leaves including any glazed or solid panels adjacent to or over the leaves within the door frame including hardware or other inbuilt features; and a door frame, if any, with its fixings to the wall and, for a sliding or tilting door, all guides and their respective fixings to the lintel, wall or sill.
Early childhood centre (ECC)	Premises used regularly for the education or care of three or more children (not being children of the persons providing the education or care, or children enrolled at a school being provided with education or care before or after school) under the age of six years old— a) by the day or part of a day; but b) not for any continuous period of more than seven days. ECC does not include home based early childhood services.
Escape height	The height between the floor level in the <i>firecell</i> being considered and the floor level of the required <i>final exit</i> which is the greatest vertical distance above or below that <i>firecell</i> . Where the firecell contains <i>intermediate floors</i> , or upper floors within <i>household units</i> the escape height shall be measured from the floor having the greatest vertical separation from the <i>final exit</i> .
Escape route	A continuous unobstructed route from any <i>occupied space</i> in a <i>building</i> to a <i>final exit</i> to enable occupants to reach a <i>safe place</i> , and shall comprise one or more of the following: <i>open paths</i> and <i>safe paths</i> . Note that doors in an escape route are not considered to be obstructions provided they comply with this Acceptable Solution and D1/AS1.
Exitway	All parts of an <i>escape route</i> protected by <i>fire</i> or <i>smoke separations</i> , or by distance when exposed to open air, and terminating at a <i>final exit</i> .
External wall	Any exterior face of a <i>building</i> (including a roof) within 30° of vertical, consisting of <i>primary</i> and/or <i>secondary elements</i> intended to provide protection against the outdoor environment, but which may also contain <i>unprotected areas</i> .
Final exit	The point at which an <i>escape route</i> terminates by giving direct access to a <i>safe place</i> .
Fire	The state of combustion during which flammable materials burn producing heat, toxic gases, or smoke or flame or any combination of these.



Firecell	Any space including a group of contiguous spaces on the same or different levels within a <i>building</i> , which is enclosed by any combination of <i>fire separations</i> , <i>external walls</i> , roofs, and floors. Floors, in this context, include ground floors and those in which the underside is exposed to the external environment (eg when cantilevered). Note that internal floors between <i>firecells</i> are <i>fire separations</i> .
Fire damper	A device with a specified <i>FRR</i> complete with fixings and operating mechanism for automatically closing off an airway where it passes through a <i>fire separation</i> . An airway may be a duct, plenum, ceiling space, roof space or similar <i>construction</i> used for the passage of ventilating air.
Fire door	A doorset, single or multi-leaf, having a specific <i>fire resistance rating</i> , and in certain situations a smoke control capability, and forming part of a <i>fire separation</i> . The door, in the event of <i>fire</i> , if not already closed, will close automatically and be self-latching.
Fire hazard	The danger of potential harm and degree of exposure arising from— a) the start and spread of <i>fire</i> ; and b) the smoke and gases that are generated by the start and spread of <i>fire</i> .
Fire load	The sum of the net calorific values of the <i>combustible</i> contents which can reasonably be expected to burn within a <i>firecell</i> , including furnishings, built-in and removable materials, and <i>building elements</i> . The calorific values shall be determined at the ambient moisture content or humidity.
Fireplace	A space formed by the <i>chimney back</i> , the <i>chimney jambs</i> , and the <i>chimney breast</i> in which fuel is burned for the purpose of heating the room into which it opens.
Fire resistance rating (FRR)	The term used to describe the minimum <i>fire</i> resistance required of <i>primary</i> and <i>secondary elements</i> as determined in the <i>standard test</i> for <i>fire</i> resistance, or in accordance with a specific calculation method verified by experimental data from standard <i>fire</i> resistance tests. It comprises three numbers giving the time in minutes for which each of the criteria <i>structural adequacy</i> , <i>integrity</i> and <i>insulation</i> are satisfied, and is presented always in that order. There are two types of <i>FRR</i> : <i>life rating</i> and <i>property rating</i> .
Fire resisting closure	A <i>fire</i> rated device or assembly for closing an opening through a <i>fire separation</i> . A <i>fire resisting closure</i> is intended to include <i>fire doors</i> , <i>fire windows</i> or access panels. In this context the opening may be used to permit passage of people or goods, or to transmit light, but does not include an opening to permit the passage of <i>building services</i> .
Fire resisting glazing	Fixed or openable glazing, complete with frame and fixings, mullions, transoms and glazing beads, with a specified <i>FRR</i> and complying with NZS 4232.2.
Fire retardant	A substance or a treatment, incorporated in or applied to a material, which suppresses or delays the combustion of that material under specified conditions.

Fire safety systems	The combination of all active and passive protection methods used in a <i>building</i> to— a) warn people of an emergency; and b) provide for safe evacuation; and c) provide for access by, and the safety of, firefighters; and d) restrict the spread of <i>fire</i> ; and e) limit the impact of <i>fire</i> on <i>structural stability</i> .
Fire separation	Any <i>building element</i> which separates <i>firecells</i> or <i>firecells</i> and <i>safe paths</i> , and provides a specific <i>fire resistance rating</i> .
Fire shutter	A <i>fire rated device</i> , complete with fixings and operating mechanism, for automatically closing off an opening in a <i>fire separation</i> or <i>protected shaft</i> .
Fire stop	A material or method of <i>construction</i> used to restrict the spread of <i>fire</i> within or through <i>fire separations</i> , and having a <i>FRR</i> no less than that of the <i>fire separation</i> . Fire stops are mainly used to seal around penetrations, but can also be used to seal narrow gaps between building elements.
Fixture	An article intended to remain permanently attached to and form part of a <i>building</i> .
Flammability index (FI)	That index number for flammability, which is determined according to the <i>standard test</i> method for flammability of thin flexible materials.
Flue	The passage through which the products of combustion are conveyed to the outside.
Flue liner	Pipes or linings of <i>fire clay</i> , metal or <i>fire brick</i> that surrounds <i>flues</i> .
Flue system	A series of interconnecting <i>flue</i> pipe casings which form a safe passage ( <i>flue</i> ) for conveying products of combustion from within an appliance to the outside of a <i>building</i> or structure.
Foamed plastics	<i>Combustible</i> foamed plastic polymeric materials of low density (typically less than 100 kg/m <sup>3</sup> ) and classified as cellular polymers which are manufactured by creating a multitude of fine void (typically 90 to 98%) distributed more or less uniformly throughout the product. Examples of <i>foamed plastics</i> are latex foams, polyethylene foams, polyvinyl chloride foams, expanded or extruded polystyrene foams, phenolic foams, ureaformaldehyde foams, polyurethane foams and polychloropene foams.
Group Number	The classification number for a material used as a finish, surface, lining, or attachment to a wall or ceiling within an <i>occupied space</i> and determined according to the <i>standard test</i> methods for measuring the properties of lining materials. The method for determining a Group Number is described in C/VM2 Appendix A.

Amend 2  
Nov 2020

Group sleeping area	A <i>firecell</i> containing communal sleeping accommodation for a specified number of people who may or may not be known to one another.
Handrail	A rail to provide support to, or assist with the movement of a person.
Hazardous	Creating an unreasonable risk to people of bodily injury or deterioration of health.
Hazardous substance	Has the meaning ascribed to it by section 2 of the Hazardous Substances and New Organisms Act 1996.
Hearth	The insulating floor under the <i>fire</i> and in front and at the sides of the <i>fireplace</i> .
Hold-open device	A device which holds a <i>smoke control door</i> or <i>fire door</i> open during normal use, but is released by deactivating the device by an automatic <i>fire</i> detection system, allowing the door to close automatically under the action of a self-closing device.
Household unit	<p>a) means a <i>building</i> or group of <i>buildings</i>, or part of a <i>building</i> or group of <i>buildings</i>, that is—</p> <ul style="list-style-type: none"> <li>i) used, or intended to be used, only or mainly for residential purposes; and</li> <li>ii) occupied, or intended to be occupied, exclusively as the home or residence of not more than 1 household; but</li> </ul> <p>b) does not include a hostel, boarding house, or other specialised accommodation.</p>
HVAC	An abbreviation for heating, ventilating and air-conditioning.
Insulating material	A material that has a thermal conductivity of less than 0.07 W/mK.
Insulation	In the context of <i>fire</i> protection, the time in minutes for which a prototype specimen of a <i>fire separation</i> , when subjected to the <i>standard test for fire</i> resistance, has limited the transmission of heat through the specimen.
Integrity	In the context of <i>fire</i> protection, the time in minutes for which a prototype specimen of a <i>fire separation</i> , when subjected to the <i>standard test for fire</i> resistance, has prevented the passage of flame or hot gases. The precise meaning of <i>integrity</i> depends on the type of <i>building elements</i> being treated and how it is defined in the <i>standard test</i> being used.

Intended use	In relation to a <i>building</i> ,— a) includes any or all of the following: i) any reasonably foreseeable occasional use that is not incompatible with the intended use; ii) normal maintenance; iii) activities undertaken in response to <i>fire</i> or any other reasonably foreseeable emergency; but b) does not include any other maintenance and repairs or rebuilding.
Intermediate floor	Any upper floor within a <i>firecell</i> which because of its configuration provides an opening allowing smoke or <i>fire</i> to spread from a lower to an upper level within the <i>firecell</i> .
Life rating	The <i>fire resistance rating</i> to be applied to elements of <i>construction</i> that allows movement of people from their location in a <i>building</i> to a <i>safe place</i> .
Limited combustible	A material that does not comply with the requirements for a <i>non-combustible</i> material and is classified as A2 in accordance with BS EN 13501-1.
Means of escape from fire	In relation to a <i>building</i> that has a floor area— a) means continuous unobstructed routes of travel from any part of the floor area of that <i>building</i> to a place of safety; and b) includes all active and passive protection features required to warn people of <i>fire</i> and to assist in protecting people from the effects of <i>fire</i> in the course of their escape from the <i>fire</i> .
Multi-unit dwelling	Applies to a <i>building</i> or use which contains more than one separate household or family.
Non-combustible	Material either— a) composed entirely of glass, concrete, steel, brick/block, ceramic tile, or aluminium; or b) classified as non-combustible when tested to AS 1530.1; or c) classified as A1 in accordance with BS EN 13501-1.
Notional boundary	The <i>boundary</i> which for <i>fire</i> safety purposes, is assumed to exist between two <i>buildings</i> on the same property under a single land title. The <i>notional boundary</i> is not permitted to be located any closer than 1.0 metre to any unprotected areas within the <i>external wall</i> of the <i>building</i> that is receiving the radiation where orientated at less than 90°.
Occupant load	The greatest number of people likely to occupy a particular space within a <i>building</i> . It is determined by: a) dividing the total floor area by the m <sup>2</sup> per person (occupant density) for the activity being undertaken, or b) for sleeping areas, counting the number of sleeping (or care) spaces, or c) for fixed seating areas, counting the number of seats.
Occupied space	Any space within a <i>building</i> in which a <i>person</i> will be present from time to time during the <i>intended use</i> of the <i>building</i> .
Open path	That part of an <i>escape route</i> (including <i>dead ends</i> ) within a <i>firecell</i> where occupants may be exposed to <i>fire</i> or smoke while making their escape.

Amend 2  
Nov 2020Amend 2  
Nov 2020

Open space	Land on which there are, and will be, no <i>buildings</i> and which has no roof over any part of it other than overhanging eaves.
Other property	Any land or <i>buildings</i> or part of any land or <i>buildings</i> , that are: <ul style="list-style-type: none"> <li>a) not held under the same <i>allotment</i>; or</li> <li>b) not held under the same <i>ownership</i>; and</li> <li>c) includes a <i>road</i>.</li> </ul>
Owner	In relation to land and any <i>buildings</i> on the land— <ul style="list-style-type: none"> <li>a) means the <i>person</i> who— <ul style="list-style-type: none"> <li>i) is entitled to the rack rent from the land; or would be so entitled if the land were let to a tenant at a rack rent; and</li> </ul> </li> <li>b) includes— <ul style="list-style-type: none"> <li>i) the <i>owner</i> of the fee simple of the land; and</li> <li>ii) for the purposes of Building Act sections 32, 44, 92, 96, 97, and 176(c), any person who has agreed in writing, whether conditionally or unconditionally, to purchase the land or any leasehold estate or interest in the land, or to take a lease of the land, and who is bound by the agreement because the agreement is still in force.</li> </ul> </li> </ul>
Penetration	A <i>building element</i> passing through an opening in a <i>fire separation</i> . A <i>penetration</i> may include, but is not limited to: pipes, cables, ducts, hoses, drains, cable trays, ropes, data outlets, power outlets, hatches, glazing, structural bracing etc.
People with disabilities	People whose ability to use <i>buildings</i> is affected by mental, physical, hearing or sight impairment.
Place of safety	Either— <ul style="list-style-type: none"> <li>a) a <i>safe place</i>; or</li> <li>b) a place that is inside a <i>building</i> and meet the following requirements: <ul style="list-style-type: none"> <li>i) the place is constructed with <i>fire separations</i> that have fire resistance sufficient to withstand burnout at the point of the fire source; and</li> <li>ii) the place is in a <i>building</i> that is protected by an automatic fire sprinkler system that complies with NZS 4541 or NZS 4515 as appropriate to the <i>building's</i> use; and</li> <li>iii) the place is designed to accommodate the intended number of persons; and</li> <li>iv) the place is provided with sufficient means of escape to enable the intended number of persons to escape to a <i>safe place</i> that is outside a <i>building</i>.</li> </ul> </li> </ul>
Primary element	A <i>building element</i> providing the basic loadbearing capacity to the structure, and which if affected by fire may initiate instability or premature structural collapse.
Property rating	The <i>fire resistance rating</i> to be applied to elements of <i>construction</i> that allows for protection of <i>other property</i> .
Protected shaft	A space, other than a <i>safe path</i> , enclosed by <i>fire separations</i> or <i>external walls</i> used to house <i>building</i> services, lifts, or conveyors which pass from one <i>firecell</i> to another.
Railway line	Has the meaning ascribed to it by section 4 of the Railways Act 2005.

Relevant boundary	<p>The <i>boundary</i> of an <i>allotment</i> that is <i>other property</i> in relation to the <i>building</i> in question and from which is measured the separation between the <i>building</i> and that <i>other property</i>; and for the <i>external wall</i> of any <i>building</i>, the <i>relevant boundary</i> is the nearest of—</p> <ul style="list-style-type: none"> <li>a) a <i>boundary</i> of a freehold <i>allotment</i>, except that if the <i>other property</i> is a <i>road</i>, <i>railway line</i>, or <i>public open space</i>, the <i>relevant boundary</i> is the <i>boundary</i> on the far side of that <i>other property</i>; or</li> <li>b) a <i>boundary</i> of a cross-lease or a company lease or a licence, except that if the <i>other property</i> is <i>open space</i> to which the lessee or licensee of the <i>building</i> in question has an exclusive right of access and occupation or to which 2 or more occupiers of the <i>building</i> in question have rights of access and occupation, the <i>relevant boundary</i> is the <i>boundary</i> on the far side of that <i>other property</i>; or</li> <li>c) a <i>boundary</i> shown on a unit plan (but excluding a <i>boundary</i> between a principal unit and its accessory unit), except that if the <i>other property</i> is <i>open space</i> and is common property, the <i>relevant boundary</i> is the <i>boundary</i> on the far side of that <i>other property</i>.</li> </ul> <p>Refer also to <i>notional boundary</i> for <i>buildings</i> on the same property under a single land title.</p>
Risk group	The classification of a <i>building</i> or <i>firecells</i> within a <i>building</i> according to the use to which it is intended to be put.
Road	Has the meaning ascribed to it by section 315 of the Local Government Act 1974 and includes a public place and also includes a motorway.
Safe path	That part of an <i>exitway</i> which is protected from the effects of <i>fire</i> by <i>fire separations</i> , <i>external walls</i> , or by distance when exposed to open air.
Safe place	A place, outside of and in the vicinity of a single <i>building</i> unit, from which people may safely disperse after escaping the effects of a <i>fire</i> . It may be a place such as a street, <i>open space</i> , public space or an <i>adjacent building</i> unit.
Safety glass	Means glass so treated or combined with other materials as to reduce the likelihood of injury to persons when it is cracked or broken.
Secondary element	A <i>building element</i> not providing load bearing capacity to the structure and if affected by <i>fire</i> , instability or collapse of the <i>building</i> structure will not occur.
Smokecell	A space within a <i>building</i> which is enclosed by an envelope of <i>smoke separations</i> , or <i>external walls</i> , roofs, and floors.
Smoke control door	A <i>doorset</i> that complies with Appendix C, C6.1.2 of this Acceptable Solution.
Smoke damper	A <i>fire damper</i> whose closing action is initiated by the detection of smoke.
Smoke lobby	That portion of an <i>escape route</i> within a <i>firecell</i> that precedes a <i>safe path</i> or an <i>escape route</i> through an adjoining <i>building</i> which is protected from the effects of smoke by <i>smoke separations</i> .

Smoke separation	<p>Any <i>building element</i> able to prevent the passage of smoke between two spaces. <i>Smoke separations</i> shall:</p> <p>Be a smoke barrier complying with BS EN 12101 Part 1, or comply with the following</p> <p>a) Consist of rigid <i>building elements</i> capable of resisting without collapse:</p> <p>i) a pressure of 0.1 kPa applied from either side, and</p> <p>ii) self-weight plus the intended vertically applied live loads, and</p> <p>b) Form an imperforate barrier to the spread of smoke, and</p> <p>c) Be of non-combustible construction, or achieve a FRR of 10/10/-, except that non-fire resisting glazing may be used if it is toughened or laminated safety glass.</p>
Stability	In the context of <i>fire</i> protection is the support provided to a <i>building element</i> having a FRR, intended to avoid premature failure due to structural collapse as a result of applied load, dead and live loads or as a result of any additional loads caused by <i>fire</i> .
Stairway	A series of steps or stairs with or without landings, including all necessary <i>handrails</i> and giving access between two different levels.
Standard test	A test method which is recognised as being appropriate for the <i>fire</i> protection properties being assessed. Refer Appendix C for a list of <i>standard test</i> methods.
Structural adequacy	In the context of the <i>standard test</i> for <i>fire</i> resistance, is the time in minutes for which a prototype specimen has continued to carry its applied load within defined deflection limits. The <i>fire</i> design load should be as specified in B1/VM1.
Suite	A <i>firecell</i> providing residential accommodation for the exclusive use of one <i>person</i> or of several people known to one another. It comprises one or more rooms for sleeping and may include spaces used for associated domestic activities such as hygiene and cooking. A <i>suite</i> may include transient or educational accommodation.
Surface finish	The combination of a surface coating and substrate material on surfaces of <i>building elements</i> exposed to view. It can be an applied decorative coating or the uncoated <i>building element</i> itself. For interior surfaces the requirements are evaluated in terms of a <i>Group Number</i> .
Theatre	A place of assembly intended for the production and viewing of performing arts, and consisting of an auditorium and stage with provision for raising and suspending stage scenery above and clear of the working area.
Travel distance	<p>The length of the <i>escape route</i> as a whole or the individual lengths of its parts, namely:</p> <p>a) <i>open paths</i>, and</p> <p>b) <i>safe paths</i>.</p>

Amend 2  
Nov 2020

Amend 2  
Nov 2020

Unprotected area	<p>In relation to an <i>external wall</i> of a <i>building</i>, means:</p> <ul style="list-style-type: none"><li>a) Any part of the <i>external wall</i> which is not <i>fire</i> rated or has less than the required <i>FRR</i>, and</li><li>b) Any part of the <i>external wall</i> which has <i>combustible</i> material more than 1.0 mm thick attached or applied to its external face, whether for cladding or any other purpose.</li></ul> <p><i>Unprotected areas</i> include non-<i>fire</i> rated windows, doors, or other openings, and non-<i>fire</i> rated <i>external wall construction</i>.</p>
Wharenui	A communal meeting house having a large open floor area used for both assembly and sleeping in the traditional Māori manner.



# Part 1: General

## CONTENTS

- 1.1 Introduction and scope
- 1.2 Using this Acceptable Solution
- 1.3 Alterations to buildings
- 1.4 Calculating occupant loads

### 1.1 Introduction and scope

This Acceptable Solution is one of three Acceptable Solutions that provide a means of establishing compliance with NZBC Clauses C1 to C6 Protection from Fire. It can be used for the *building* activities covered by *risk groups* specified in Paragraph 1.1.1 and described in Table 1.1.

For **risk group SH**, please refer to Acceptable Solution C/AS1.

For *backcountry huts*, please refer to Acceptable Solution BCH/AS1.


Where a specific *risk group* (or *risk groups*) is mentioned in a subheading and/or within the text of a paragraph, that requirement applies only to the specified *risk group(s)*, and does not apply to other *risk groups*.

Words in *italic* are defined at the front of this document.

Appendices to this Acceptable Solution are part of, and have equal status to, the Acceptable Solution.

Figures and *risk group* icons are informative only; the wording of the paragraphs takes precedence.

### Risk group icons

 **Solid red circles**  
Applies to particular *risk group* requirements


 **White circles with red bar**  
Requirement excludes the particular *risk group*

Table 1.1		Risk groups: scope and limitations	
	Risk group	Applies to	
Amend 2 Nov 2020	C/AS1 <b>SH</b> Buildings with sleeping (residential) and outbuildings  (Out of scope for this Acceptable Solution)	<p><b>Detached dwellings with a single household unit such as:</b> stand-alone houses</p> <p><b>Low-rise multi-unit dwellings where each household unit has its own escape route that is independent of all other household units such as:</b> Attached townhouses. Stacked <i>household units</i> where there is no more than one <i>household unit</i> above another with each <i>household unit</i> having a single storey and an <i>escape height</i> less than 4.0 m.</p> <p><b>Detached dwellings where fewer than six people (not including members of the residing family) pay for accommodation such as:</b> boarding houses, homestays, bed and breakfast.</p> <p><b>Outbuildings.</b></p>	
	Acceptable Solution C/AS2	<b>SM</b> Sleeping (non-institutional)	<p><b>Permanent accommodation such as:</b> Apartment <i>buildings</i> and other <i>buildings</i> which consist of more than one <i>household unit</i> (other than low-rise <i>multi-unit dwellings</i> in the scope of <b>risk group SH</b>).</p> <p><b>Transient accommodation such as:</b> Hotels, motels, serviced apartments, hostels, backpackers, cabins at holiday parks. <i>Buildings</i> where six or more people pay for accommodation (such as boarding houses/homestays/ bed and breakfast). <i>Wharenui</i> and other community sleeping spaces such as halls (even if used occasionally). Sheltered housing such as refuges, reintegration for prisoners, homeless shelters etc.</p> <p><b>Educational accommodation such as:</b> University halls of residence, school boarding hostels etc.</p>
<b>SI</b> Care or detention		<p><b>Care activities such as:</b> Institutions, hospitals including outpatients and day procedures (excluding special care facilities such as operating theatres, intensive care units, prisons, delivery and recovery rooms and hyperbaric chambers or other such places that require stay in place strategies). Aged care facilities. Residential care in institutions, hospices. Medical day treatment: i.e. medical centres and dental practices using sedation or treatment rooms where people are unable to self-evacuate without assistance; e.g. for dialysis or chemotherapy. Care in the community houses and homes.</p> <p><b>Detention facilities (excluding prisons) such as:</b> Police stations, court <i>buildings</i> and hospitals with detention facilities.</p>	
<b>CA</b> Public access and educational facilities		<p><b>Crowd activities such as:</b> Halls, <i>theatres</i> and cinemas. Recreation and event centres (including tiered seating for up to 2000 people and with any primary egress for more than 100 people at the level of the playing surface). Educational institutions without sleeping including schools and <i>early childhood centres</i>. Churches and other places of worship. Restaurants and cafes, shops and shopping malls. Exhibition, retail areas including car showrooms and trade fair space. Public libraries with less than 2.4 m storage height. Spaces for viewing open air activities (does not include spaces below a grandstand), open grandstands, roofed but unenclosed grandstand, uncovered fixed seating).</p> <p><b>Personal service activities such as:</b> Dentists, doctors (except as included within <b>risk group SI</b>), banks, beautician and hairdressing salons.</p>	
<b>WB</b> Business, commercial and low level storage		<p><b>Professional activities such as:</b> Offices (including professional services such as law and accountancy practices). Laboratories, workshops (including mechanics workshops). May contain storage with a capable height of storage of less than 3.0 m.</p> <p><b>Industrial activities such as:</b> Factories, processing and manufacturing plants (excluding <i>foamed plastics</i>) with a capable height of storage of less than 3.0 m.</p> <p><b>Storage activities such as:</b> <i>Buildings</i> or parts of <i>buildings</i> capable of storage no more than 5.0 m in height. Warehouses and storage <i>buildings</i> (other than those listed above), capable of storage more than 5.0 m in height, but a height to the apex no greater than 8.0 m and total floor area of no more than 4200 m<sup>2</sup>. Temperature controlled storage with a capable height of storage of less than 3.0 m, other than some limited areas in processing areas, or up to a maximum area of 500 m<sup>2</sup> with a maximum capable of storage height of 5.0 m.</p> <p><b>Intermittently occupied buildings (other than outbuildings) such as:</b> Light aircraft hangers, <i>buildings</i> containing fixed plant and or fixed machinery and spray painting operations, whether or not in a spray booth.</p>	
Errata 1 Oct 2019			

Table 1.1 Risk groups: scope and limitations		
	Risk group	Applies to
Acceptable Solution C/AS2	<b>WS</b> High level storage or potential for fast fire growth	<b>Storage activities such as:</b> Warehouses with a capable height of storage of over 5.0 m or over 8.0 m to the apex and total floor area greater than 4200 m <sup>2</sup> . Temperature controlled storage outside of the scope of <b>risk group WB</b> . <b>Service activities such as:</b> Trading and bulk retail wholesalers with a storage height greater than 3.0 m. Supermarkets with shelving over 3.0 m in height. Exhibition, retail areas and trade fair space with a storage height greater than 3.0 m.
	<b>VP</b> Vehicle storage and parking	<b>Vehicle parking – within a building or a separate building including:</b> Car parking <i>buildings</i> . Vehicle parking or stacking within <i>buildings</i> . Goods vehicle parking. Service vehicle and unloading areas. Car storage warehouses.
<b>Note:</b> * <i>Risk group SH</i> is outside the scope of this Acceptable Solution. Refer to C/AS1.		

**Scope**

1.1.1 The scope of this Acceptable Solution is restricted to all *risk groups* listed in Table 1.1 except for **risk group SH** (refer to C/AS1). It covers *buildings* or parts of *buildings* where people:

- SM** a) Sleep (SM), and
- SI** b) Are unable to self-evacuate without assistance through requiring special care or treatment, or they are restrained, or their liberties are restricted (SI), and
- CA** c) Congregate, participate in group activities or where professional services or retail are provided (CA), and
- WB** d) Work (WB), and
- WS** e) Store goods and other materials (WS), and
- VP** f) Park vehicles (VP).

These activities are described in Table 1.1.

**Outside the scope of this Acceptable Solution**

1.1.2 *Buildings* with complex features are outside the scope of this Acceptable Solution. Complex features include:

- a) Atriums, and
- b) *Intermediate floors*, other than limited area *intermediate floors*, and
- SI** c) Operating theatres, intensive care units, hyperbaric chambers, delivery rooms, and recovery rooms (SI), and
- CA** d) Recreation and event centres (with tiered seating for more than 2000 people) (CA), and
- e) *Buildings* more than 20 storeys high, and
- f) Prison *buildings*.

*Buildings* that have features for which solutions are not provided within this Acceptable Solution are also deemed to be complex.

1.1.3 If the Acceptable Solution cannot be followed in full, use Verification Method C/VM2 or an alternative solution to demonstrate compliance.

1.1.4 Other than where permitted for **risk group SI** and for *early childhood centres*, this Acceptable Solution allows for an ‘all out’ evacuation strategy. It does not provide features to facilitate a delayed evacuation strategy.

**SI** 1.1.5 **Risk group SI** invariably requires a *fire* safety strategy involving delayed initiation of evacuation and movement to a *place of safety* within the *building*. However, this Acceptable Solution does not provide for *building* features that would be required for a stay-in-place strategy. This applies to activities such as:

- a) Operating theatres, and
- b) Intensive care units, and
- c) Hyperbaric chambers, and
- d) Delivery rooms, and
- e) Recovery rooms.

### **The control of hazardous substances is not covered by this Acceptable Solution**

1.1.6 This Acceptable Solution does not provide for any use, storage or processing of *hazardous substances*. Compliance with NZBC Clause F3, the Hazardous Substances and New Organisms Act 1996, and the Health and Safety at Work (Hazardous Substances) Regulations 2017 shall also be ensured where applicable in addition to the requirements of this Acceptable Solution.

Amend 2  
Nov 2020

## **1.2 Using this Acceptable Solution**

1.2.1 The process for using this Acceptable Solution shall be as follows.

### **Step 1: Determine which risk group applies**

- a) Determine the *risk group* for each of the activities carried out in the *building* (refer to Table 1.1 and Paragraph 1.1.1). If the activity is not listed explicitly, choose the nearest suitable *risk group*.
- b) If there is more than one *risk group* for a *firecell*, determine its primary *risk group* (see Paragraph 1.2.2: this is the one with the most onerous *fire* safety requirements).
- c) Apply this Acceptable Solution for any *firecell* by following steps 2 and 3.
- d) Then apply the relevant parts of this Acceptable Solution for *firecells*.

### **Step 2: Determine the parameters for the various risk groups**

- a) Establish the relevant *building* measurements (these will include *building height*, floor area, wall openings and distances to *relevant boundaries*).
- b) Work out the *occupant loads* for the relevant *occupied spaces* (refer to Paragraph 1.4).

### **Step 3: Satisfy the fire safety requirements**

Satisfy the *fire* safety requirements of this Acceptable Solution (refer to Parts 2-7), based on the *occupant loads* and on the *building's* dimensions and features where required.

### **Primary risk groups**

1.2.2 If a *building* contains a number of different activities which individually may be categorised in different *risk groups*, the *risk group* designated for a particular *firecell* within a *building* shall be that of the primary *risk group*. The primary *risk group* shall be that one within the *firecell* that has the most onerous *fire* safety requirements. Other *risk groups* may be able to be incorporated within the same space provided these are ancillary to, and support, the primary *risk groups*.

1.2.3 Depending on the particular *building* and the uses or activities within that *building*, there may be several primary *risk groups*, with one or more on each floor.

## **1.3 Alterations to buildings**

1.3.1 This Acceptable Solution may be used to determine the compliance of *building work* (in relation to an existing *building*).

## 1.4 Calculating occupant loads

### Occupant load

**1.4.1** The *occupant load* shall be determined from the *risk group* and number of people in each space of the *building*. The *occupant load* may need to be evaluated not only for each *risk group* but also for:

- a) A space or open floor area involving one or more activities, and
- b) A floor containing more than one *risk group*, and
- c) A single *firecell*, and
- d) Each floor within a *firecell*.

**1.4.2** *Occupant loads* shall be calculated from the occupant densities given in Table 1.2 based on the floor area of the part of the *building* housing the activity. The occupant densities in Table 1.2 already allow for a proportion of the floor area appropriate to the activity being occupied by furniture, partitions, *fixtures* and associated equipment. If a *building space* has alternative activity uses, the activity having the greatest occupant density shall be used. If an activity is not specifically described in Table 1.2, the nearest reasonable description shall be used.

**1.4.3** Duplication shall be avoided by:

- a) Ensuring that, where people may be involved in more than one activity, they are counted only once, and
- b) Not including an *occupant load* for *exitways*, or for the *occupant load* determined for areas such as lift lobbies or sanitary facilities that are used intermittently by people already counted elsewhere in the *building*.

### Fixed seating

**1.4.4** *Occupant load* assessment shall take account of the actual arrangement and number of seats for fixed seating (see Paragraph 3.7.4). Where additional floor area abuts the fixed seating, additional occupants are permitted in that floor area based on standing space density, provided the *escape route* is not obstructed.

### Bed spaces

**1.4.5** The requirements of this Acceptable Solution account for the fact that other people may be present in the *building* or *firecell* and additional calculations are not required when an *occupant load* is derived by bed spaces (i.e. for **risk groups SM** and **SI**).

**SI** **1.4.6** For the purposes of **risk group SI** the term 'bed' means the number of people that are under care or detention. It can include people on:

- a) Beds, or
- b) Recliner or lounge chairs, or
- c) Dentist chairs, or
- d) Treatment tables, or
- e) Any other furniture where an occupant may be for a period of treatment, in care or detention.

### Justification for exceptions

**1.4.7** If, in a particular situation, the *occupant load* derived from Table 1.2 is clearly more than that which will occur, the basis of any proposal for a lesser *occupant load* shall be substantiated to the *building consent authority*.

**1.4.8** If the maximum *occupant load* is greater than that calculated from Table 1.2, the higher number shall be used as the basis for the *fire safety design* and will need to be justified to the *building consent authority*.

Activity	Occupancy density (m <sup>2</sup> / person)
Aircraft hangars	50
Airports – baggage areas	2
– waiting areas, check in	1.4
– terminal space	10
Area without seating or aisles	1
Art galleries, museums	4
Bar sitting areas	1
Bar standing areas	0.5
Bleachers, pews or bench-type seating	0.45 linear m per person
Boiler rooms, plant rooms	30
Bulk storage including racks and shelves	100
Bulk retail (trading stores, supermarkets etc)	5
Call centres	7
Care and detention	Bed spaces, see Paragraph 1.4.6
Classrooms	2
Commercial kitchens	10
Commercial laboratories, laundries	10
Computer server rooms	25
Consulting rooms (doctors, dentists, beauty therapy)	5
Dance floors	0.6
Day care centres	4
Dining, restaurant and cafeteria spaces	1.25
<i>Early childhood centres</i>	Based on Education (Early Childhood Services) Regulations 2008 plus the number of staff
Exhibition areas, trade fairs	1.4
Fitness centres/weights rooms	5
Gaming, casino areas	1
Heavy industry	30
Indoor games areas, bowling alleys	10
Interview rooms	5
Libraries: stack areas	10
Libraries: other areas	7
Lobbies and foyers	1
Mall areas used for assembly uses	1
Manufacturing and process areas	10
Meeting rooms	2.5
Office spaces	10

<b>Activity</b>	<b>Occupancy density (m<sup>2</sup>/ person)</b>
Parking buildings, garages	50
Personal service facilities	5
Reading or writing rooms and lounges	2
Retail spaces and pedestrian circulation areas including malls and arcades	3.5
Retail spaces for furniture, floor coverings, large appliances, building supplies and Manchester	10
Reception areas	10
Showrooms	5
Sleeping non institutional	Bed spaces
Space with fixed seating	As number of seats
Space with loose seating	0.8
Space with loose seating and tables	1.1
Sports halls	3
Stadiums and grandstands	0.6
Staffrooms and lunchrooms	5
Stages for theatrical performances	0.8
Standing space	0.4
Swimming pools (water surface area)	5
Swimming pools: surrounds and seating	3
Teaching laboratories	5
Technology classrooms (e.g. woodwork, metalwork, food science and sewing)	10
Workrooms, workshops	5

# Part 2: Firecells, fire safety systems and fire resistance ratings

## CONTENTS

- 2.1 Provision of firecells
- 2.2 Fire safety systems
- 2.3 Fire resistance ratings

### 2.1 Provision of firecells

#### Firecell floor area limits

2.1.1 The floor area of *firecells* shall be limited in accordance with Table 2.1.

Risk group	Unsprinklered	Sprinklered
SM	500	Unlimited <sup>1</sup>
SI	n/a	500
CA	5000	Unlimited <sup>1</sup>
WB	5000 <sup>2</sup>	Unlimited <sup>1</sup>
WS	n/a	Unlimited <sup>1</sup>
VP	5000 <sup>2</sup>	Unlimited <sup>1</sup>

**Notes:**

1. Except where the *Acceptable Solution* requires *fire separations* or other area limitations
2. When 15 m or greater from a *relevant boundary*, the *firecell* floor area is unlimited, except where the *Acceptable Solution* requires *fire separations* or other area limitations



## 2.2 Fire safety systems

2.2.1 *Fire safety system* types, as defined in Table 2.2, shall be provided throughout *firecells* and be as specified in:

- SM SI** • Table 2.2a for **risk groups SM** and **SI**, and
- CA** • Table 2.2b for **risk group CA**, and
- WB WS** • Table 2.2c for **risk groups WB** and **WS**, and
- VP** • Table 2.2d for **risk group VP**.

A direct connection to Fire and Emergency New Zealand is not required if automatic heat or smoke detection systems are provided in addition to the systems required by this Acceptable Solution.

### **CA** Additional requirements for early childhood centres

2.2.2 In addition to Paragraph 2.2.1, the *fire safety systems* required for *firecells* in *early childhood centres* shall be as follows:

- a) In single storey *early childhood centres*, dedicated sleeping areas shall be protected with supplementary smoke detectors. The alarm system and any smoke detection system shall comply with NZS 4512.
- b) Where the *escape height* of the *early childhood centre* is greater than 2.0 m:
  - i) a Type 7 system shall be installed throughout the *building*, and
  - ii) at least two separate *places of safety* shall be provided, and
  - iii) each *place of safety* shall be separated with *fire separations* designed to the *property rating* and have direct access to a *safe path* or *final exit*.

Amend 2  
Nov 2020

## Buildings containing more than one firecell

2.2.3 Where there is more than one *firecell* the following design sequence shall be used to determine the *fire safety systems* for other *firecells* in the *building* (see Figure 2.1).

**Step 1** Determine the *risk groups* associated with each *firecell* within the *building* (refer Table 1.1 and Paragraphs 1.2.1 and 1.2.2).

**Step 2** Determine the *escape height* in metres of each *firecell*.

**Step 3** Determine the *occupant load* for each *firecell* in accordance with Paragraph 1.4.

**Step 4** Taking into consideration the notes within Tables 2.2a, 2.2b, 2.2c and 2.2d and Paragraph 2.2.2 determine the *fire safety systems* required to protect each *risk group*.

**Step 5** For each *risk group*, insert the *fire safety system* ascertained in Step 4 into Table 2.3 column 1 and determine the *fire safety system* for the other *risk groups* in the *building* from Table 2.3 column 2.

- VP** 2.2.4 For **risk group VP** *firecells* that require a *fire sprinkler system* (refer to Table 2.2d), the *fire sprinkler system* does not need to be extended throughout the remainder of the *building* where the **risk group VP** *firecells* are *fire separated* from the adjacent *firecells*. The *fire separation* between adjacent *firecells* is required to be provided with the greater of the *property rating* of the adjacent *firecells* (refer to Table 2.4).

**Step 6** Based on the *fire safety systems* ascertained in Step 5, determine the most onerous requirements from Tables 2.2a, 2.2b, 2.2c, 2.2d and 2.3.

Table 2.2 Fire safety systems specified in this Acceptable Solution		
System Type	System description	Relevant Standards for installation
1	Domestic smoke alarm	Acceptable Solution F7/AS1
2	Manual <i>fire</i> alarm system	NZS 4512
3	Automatic <i>fire</i> alarm system activated by heat detectors and manual call points	NZS 4512
4	Automatic <i>fire</i> alarm system activated by smoke detectors and manual call points	NZS 4512
5	Automatic fire alarm system with modified smoke detection and manual call points	NZS 4512 and Acceptable Solution F7/AS1
6	Automatic <i>fire</i> sprinkler system with manual call points	NZS 4541 and NZS 4512
7	Automatic <i>fire</i> sprinkler system with smoke detection and manual call points	NZS 4541 or NZS 4515 and NZS 4512
9	Smoke control in air handling system	AS/NZS 1668.1 and NZS 4512
15	Fire and Emergency New Zealand lift control	NZS 4332
18	<i>Building fire</i> hydrant system	NZS 4510

Table 2.2a Minimum fire safety systems by type required for sleeping uses, risk groups SM and SI						
Risk group	Occupant type	Escape height (metres)				
		0	< 4	≥ 4 to < 10	≥ 10 to < 25	≥ 25
SM	Permanent	1, 2 <sup>1</sup> , 18 <sup>4</sup>	1, 2 <sup>1</sup> , 18 <sup>4</sup>	1, 2 <sup>1</sup> , 18 <sup>4</sup>	5, 15, 18 <sup>4</sup>	5, 7, 9, 15, 18
	Transient	5 <sup>2</sup> , 18 <sup>4</sup>	5, 18 <sup>4</sup>	5, 18 <sup>4</sup>	5, 15, 18 <sup>4</sup>	5, 7, 9, 15, 18
	Education	5, 7, 9, 18 <sup>4</sup>	5, 7, 9, 18 <sup>4</sup>	5, 7, 9, 18 <sup>4</sup>	5, 7, 9, 15, 18 <sup>4</sup>	5, 7, 9, 15, 18
SI	Care or Detention	7 <sup>3</sup> , 9, 18 <sup>4</sup>	7 <sup>3</sup> , 9, 18 <sup>4</sup>	7 <sup>3</sup> , 9, 18 <sup>4</sup>	7 <sup>3</sup> , 9, 15, 18 <sup>4</sup>	7 <sup>3</sup> , 9, 15, 18

**Notes:**

**Fire safety system types are as defined in Table 2.2.**

- This system is not required where the *escape route* serves no more than 10 beds or the exit doors from sleeping area *firecells* open directly into a *safe place* or external *safe path*. Direct connection to Fire and Emergency New Zealand is not required if a phone is available for 111 calls.
- This system is not required where either the *escape routes* serve no more than 10 beds, or the exit doors from individual units open directly into a *safe place* or external *safe path*. Where a Type 5 system is not required, each unit shall be provided with Type 1 smoke alarms.
- Water supplies for the sprinkler system may be a single supply which may be a public reticulated main, except if there are more than 100 people receiving hospital care or in detention, the water supply for the sprinkler system shall be a dual supply and shall comply with NZS 4541 or NZS 4515, with one of the supplies being independent of the public reticulated main.
- Not required where the height from Fire and Emergency New Zealand vehicular access to any floor is less than 15 m and Fire and Emergency New Zealand hose run distance to any point on any floor is less than 75 m, as measured from Fire and Emergency New Zealand vehicular access.

Table 2.2b		Minimum fire safety systems by type required for crowd uses, risk group CA <sup>1</sup>				
Risk group	Occupant load	Escape height (metres)				
		0	< 4	≥ 4 to < 10	≥ 10 to < 25	≥ 25
CA	< 100	2 <sup>2,3</sup> , 18 <sup>6</sup>	2 <sup>3</sup> , 18 <sup>6</sup>	4 <sup>4,5</sup> , 9, 18 <sup>6</sup>	4 <sup>4,5</sup> , 9, 15, 18 <sup>6</sup>	7, 9, 15, 18
	100 to 250	2 <sup>3</sup> , 18 <sup>6</sup>	2 <sup>3</sup> , 18 <sup>6</sup>	4 <sup>4,5</sup> , 9, 18 <sup>6</sup>	4 <sup>4,5</sup> , 9, 15, 18 <sup>6</sup>	7, 9, 15, 18
	251 to ≤ 1000	4 <sup>4,5</sup> , 18 <sup>6</sup>	4 <sup>4,5</sup> , 18 <sup>6</sup>	4 <sup>4,5</sup> , 9, 18 <sup>6</sup>	4 <sup>4,5</sup> , 9, 15, 18 <sup>6</sup>	7, 9, 15, 18
	> 1000	7, 9, 18 <sup>6</sup>	7, 9, 18 <sup>6</sup>	7, 9, 18 <sup>6</sup>	7, 9, 15, 18 <sup>6</sup>	7, 9, 15, 18

**Notes:**

**Fire safety system types are as defined in Table 2.2.**

1. Refer to Paragraph 2.2.2 for additional requirements that apply to *early childhood centres*.
2. This system is not required in single level *buildings* where the *escape route* serves no more than 50 people.
3. Provided the use is not as a cinema or *theatre*, a Fire and Emergency New Zealand connection is not required if a phone is available for 111 calls.
4. Where the environment is challenging for smoke detection, the Type 4 system may be substituted with a Type 3 system with supplementary smoke detection.
5. May be substituted with a Type 6 system where the *building's occupant load* does not exceed 500, each floor is a *firecell*, *intermediate floors* comply with Paragraph 4.13.4, and there are no sleeping area *firecells* within the *building*.
6. Not required where the height from Fire and Emergency New Zealand vehicular access to any floor is less than 15 m and Fire and Emergency New Zealand hose run distance to any point on any floor is less than 75 m, as measured from Fire and Emergency New Zealand vehicular access.

Errata 1  
Oct 2019

Errata 1  
Oct 2019

Table 2.2c		Minimum fire safety systems by type required for working uses, risk groups WB and WS				
Risk group	Occupant load	Escape height (metres)				
		0	< 4	≥ 4 to < 10	≥ 10 to < 25	≥ 25
WB	< 100	2 <sup>1,2,3</sup> , 18 <sup>7</sup>	2 <sup>2,3</sup> , 18 <sup>7</sup>	4 <sup>4,5</sup> , 9, 18 <sup>7</sup>	4 <sup>4,5</sup> , 9, 15, 18 <sup>7</sup>	7, 9, 15, 18
	100 to 250	4 <sup>4,5,6</sup> , 18 <sup>7</sup>	4 <sup>4,5,6</sup> , 18 <sup>7</sup>	4 <sup>4,5</sup> , 9, 18 <sup>7</sup>	4 <sup>4,5</sup> , 9, 15, 18 <sup>7</sup>	7, 9, 15, 18
	251 to ≤ 1000	4 <sup>4,5,6</sup> , 18 <sup>7</sup>	4 <sup>4,5,6</sup> , 18 <sup>7</sup>	4 <sup>4,5</sup> , 9, 18 <sup>7</sup>	4 <sup>4,5</sup> , 9, 15, 18 <sup>7</sup>	7, 9, 15, 18
	> 1000	7, 9, 18 <sup>7</sup>	7, 9, 18 <sup>7</sup>	7, 9, 18 <sup>7</sup>	7, 9, 15, 18 <sup>7</sup>	7, 9, 15, 18
WS	≤ 1000	6, 18 <sup>7</sup>	6, 18 <sup>7</sup>	6, 18 <sup>7</sup>	6, 15, 18 <sup>7</sup>	6, 15, 18
	> 1000	7, 18 <sup>7</sup>	7, 18 <sup>7</sup>	7, 18 <sup>7</sup>	7, 15, 18 <sup>7</sup>	7, 15, 18

**Notes:**  
**Fire safety system types are as defined in Table 2.2.**

- This system is not required in single level *buildings* (excluding storage *buildings* with a storage height greater than 3.0 m) where the *escape route* serves no more than 50 people.
- A Type 3 system is required where the storage height exceeds 3.0 m.
- A Fire and Emergency New Zealand connection is not required if a phone is available for 111 calls.
- Where the environment is challenging for smoke detection, the Type 4 system may be substituted with a Type 3 system with supplementary smoke detection.
- May be substituted with a Type 6 system where the *building's occupant load* does not exceed 500, each floor is a *firecell*, *intermediate floors* comply with Paragraph 4.13.4, and there are no sleeping area *firecells* within the *building*.
- A Type 3 system is permitted to be provided in *firecells* used for storage where the storage height is over 3.0 m.
- Not required where the height from Fire and Emergency New Zealand vehicular access to any floor is less than 15 m and Fire and Emergency New Zealand hose run distance to any point on any floor is less than 75 m, as measured from Fire and Emergency New Zealand vehicular access.

Table 2.2d		Minimum fire safety systems by type required for vehicle parking, risk group VP		
Risk group	Escape height (metres)		Vehicle stacker	
	< 10	≥ 10		
VP	2 <sup>1,2,3</sup> , 18 <sup>4</sup>	3 <sup>3</sup> , 15, 18 <sup>4</sup>	6, 18 <sup>4</sup>	

**Notes:**  
**Fire safety system types are as defined in Table 2.2.**

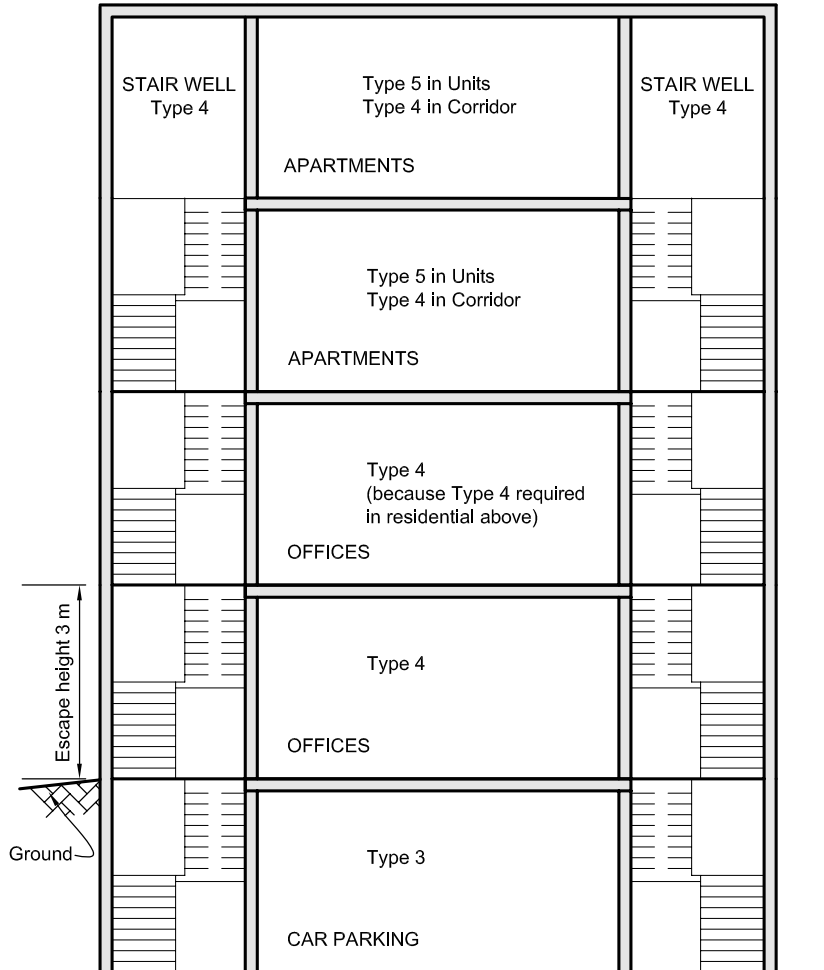
- This system is not required if there are fewer than 50 occupants and fewer than 10 vehicles.
- If **risk group VP** is within a *building* that is protected with an automatic *fire* alarm system, the **risk group VP** *firecell* must have at the minimum a Type 3 system.
- This need not be connected to Fire and Emergency New Zealand.
- Not required where the height from Fire and Emergency New Zealand vehicular access to any floor is less than 15 m and Fire and Emergency New Zealand hose run distance to any point on any floor is less than 75 m, as measured from Fire and Emergency New Zealand vehicular access.

Table 2.3		Required types of fire safety systems for other firecells within the building Read this table in conjunction with Paragraph 2.2.3			
Column 1		Column 2			
Primary risk group and alarm type required by Tables 2.2a, 2.2b, 2.2c and 2.2d		Minimum type required within other firecells on the same or other floors within the building			
		SM	CA	WB	VP
SM <sup>3</sup>	1, 2	1, 2	4 <sup>1</sup>	4 <sup>1</sup>	3
	5	5	4 <sup>1</sup>	4 <sup>1</sup>	3
	7	7	7 <sup>1</sup>	7 <sup>1</sup>	6 <sup>2</sup>
SI	7	5, 7	7	7	6
CA	2	2 <sup>3</sup>	2	2	2
	3	3 <sup>3</sup>	3	3	3
	4	5	4 <sup>1</sup>	4 <sup>1</sup>	3
	6	5, 7	6	6	6 <sup>2</sup>
	7	5, 7	7 <sup>1</sup>	7 <sup>1</sup>	6 <sup>2</sup>
WB	2	2 <sup>3</sup>	2	2	2
	3	3 <sup>3</sup>	3	3	3
	4	5	4 <sup>1</sup>	4 <sup>1</sup>	3
	6	5, 7	6	6	6 <sup>2</sup>
	7	5, 7	7 <sup>1</sup>	7 <sup>1</sup>	6 <sup>2</sup>
WS	6	5, 7	6	6	6 <sup>2</sup>
	7	5, 7	7 <sup>1</sup>	7 <sup>1</sup>	6 <sup>2</sup>
VP	2	2 <sup>3</sup>	2	2	2
	3	3 <sup>3</sup>	3	3	3
	6	5, 7	6 <sup>1</sup>	6 <sup>1</sup>	6

**Notes:**  
 The systems derived from this table show the minimum type of systems required as dictated by other *risk groups* within the *building*. Please read this table in conjunction with Tables 2.2a, 2.2b, 2.2c and 2.2d when defining the systems required within the *building*.

1. Can be changed from a Type 4 to Type 3 system, or from a Type 7 to Type 6 system if the *firecell* is challenging for smoke detection where permitted in Tables 2.2b or 2.2c.
2. Can be changed to a Type 3 if the *risk group VP firecell* is *fire separated* from the remainder of the *building* by the *building's property rating* in accordance with Paragraph 2.3.
3. Refer to Table 2.2a for additional requirements system to be provided within *risk group SM*.

Figure 2.1 Fire safety systems throughout a building Paragraph 2.2.3



### More than one risk group on a floor

2.2.5 If there is more than one *risk group* on one floor level, the *fire safety* requirements will depend on whether the *risk groups* occupy the same *firecell*, or whether the floor is divided by *fire separations* into different *firecells*.

2.2.6 Where *fire separations* are not needed between different *risk groups* on the same floor level, the *fire safety systems* adopted for the *firecell* shall be those of the primary *risk group* (as defined in Paragraph 1.2.2).

### Same risk group on different floors

2.2.7 Where *firecells* containing the same *risk group* occur at different levels in the same *building*, the *fire safety systems* for the *firecell* having the most onerous requirements shall be applied to all *firecells* of that *risk group*.

### Activation of emergency warning systems

2.2.8 The alarm systems required in a *building* shall be configured to alert all *building* occupants in the event of *fire*. This does not apply to the activation of the local smoke detection component of a Type 5 system.

**SI** 2.2.9 In **risk group SI** alerting all *building* occupants in the event of *fire* is not required where it is deemed appropriate to alert management and staff without notifying other occupants.

## 2.3 Fire resistance ratings

### FRR values

2.3.1 Unless explicitly stated otherwise in this Acceptable Solution, the *fire resistance ratings (FRRs)* that apply for each *risk group* shall be in accordance with Table 2.4.

2.3.2 Structural elements in a single storey *building* need not be *fire rated* if *FRRs* are not required for any other reason.

2.3.3 If there is more than one *risk group* on one floor in the *building*, the highest required *FRR* shall be applied to common spaces and shared *escape routes* for that floor level.

### General requirements for FRRs

2.3.4 *FRRs* shall apply to the sides of *primary elements* and *secondary elements* which are exposed to *fire*.

2.3.5 When different *FRRs* apply on each side of a *fire separation*, being a wall, the higher rating shall apply to both sides.

2.3.6 Floors shall have an *FRR* for exposure from the underside.

2.3.7 The *FRR* of a *primary element* integral with a *fire separation* shall be no less than that of the *fire separation*.

2.3.8 Except as stated in Paragraph 2.3.9, areas of *external wall* not permitted to be *unprotected areas* shall be *fire rated* from the inside only.

2.3.9 Areas of *external wall* not permitted to be *unprotected areas* shall be rated for *fire* exposure from both sides equally where:

- a) Walls are within 1 m of a *relevant boundary*, or
- b) The *building height* is more than 10 m, or
- SM SI** c) The *final exit* is two or more floor levels below any **risk group SM** or **SI** occupancy.

**2.3.10** *Building elements* shall have an *FRR* no less than that of any *building element* to which they provide support within the *firecell* or in any adjacent *firecell*.

**2.3.11** Structural framing members connected to *building elements* with an *FRR* shall be rated at no less than the *building elements* to which they are connected. Alternatively their connections and supports shall be designed so that their collapse during *fire* will not cause collapse of the *fire* rated elements.

### Applying insulation component in FRR

**2.3.12** *Insulation* ratings shall apply to:

- a) All *fire separations*, except as noted in Paragraph 2.3.13, and
- b) Parts of *external walls* that are not permitted to be *unprotected areas*, and
- c) Parts of *external walls* which are adjacent to an external *exitway* where it is a single *means of escape from fire* (refer to Paragraph 3.11.2 to determine when a *fire* rating is required).

**2.3.13** *Insulation* ratings are not required to apply to:

- a) Glazing that is exempt in accordance with Paragraph 4.2, *or*
- b) Elements where sprinklers are installed throughout the *building*, in accordance with either NZS 4541 or NZS 4515 as appropriate, *or*
- c) *Fire stops* in accordance with Paragraph 4.4.5, *or*
- d) *Fire dampers* and *damper blades* in accordance with Paragraph 4.16.12, *or*
- e) *Fire resisting glazing* in accordance with Paragraph 5.4.2.

Amend 2  
Nov 2020

Amend 2  
Nov 2020



Table 2.4 Life and property ratings in minutes				
Risk group	Unsprinklered		Sprinklered	
	Life	Property	Life	Property
SM	60	60	30	30
SI	n/a	n/a	60	60
CA	60 <sup>1</sup>	120	30 <sup>1</sup>	60
WB	60 <sup>1</sup>	120 (180 <sup>2</sup> )	30 <sup>1</sup>	60 (90 <sup>2</sup> )
WS	n/a	n/a	60 <sup>1</sup>	180
VP	60 <sup>1</sup>	60	30 <sup>3</sup>	30 <sup>3</sup>

**Notes:**

1. When the *escape height* is greater than 10 m the *exitways* shall have *fire separations* with an *FRR* meeting the *property rating* (refer to Paragraph 4.9.2).
2. Where the *building* is less than 15 m to the *relevant boundary* and the storage height is greater than 3.0 m the *FRR* shall be 90 minutes where sprinklered and 180 minutes where unsprinklered.
3. The sprinkler system can be substituted for cross ventilation in accordance with Paragraph 4.1.3.

# Part 3: Means of escape

## CONTENTS

- 3.1 General principles
- 3.2 Number of escape routes
- 3.3 Height and width of escape routes
- 3.4 Length of escape routes
- 3.5 Escape from basements
- 3.6 Open paths
- 3.7 Special cases of open paths
- 3.8 Dead ends
- 3.9 Exitways
- 3.10 Control of exitway activities
- 3.11 External escape routes
- 3.12 Final exits
- 3.13 Single escape routes
- 3.14 Special conditions
- 3.15 Doors subdividing escape routes
- 3.16 Signs

### 3.1 General principles

**3.1.1** All buildings shall have means of escape from fire which include escape routes. An escape route (see Figure 3.1) shall provide protection to any occupant escaping to a safe place from a fire within a building.

**3.1.2** The components of an escape route, in ascending order of protection, are the:

- a) Open paths, and
- b) Exitways (these may comprise of smoke lobbies and safe paths), and
- c) Final exits (see Figure 3.1).

Two or more of these components will be necessary, depending on the total travel distance.

An escape route shall not pass from a higher to lower level of protection in the direction of escape.

**3.1.3** Provided the allowable lengths of open paths are not exceeded, an escape route may comprise only an open path and final exit.

**3.1.4** Escape routes shall comply with NZBC Clause D1. Ramps, stairs, ladders, landings, handrails, doors, vision panels and openings shall comply with Acceptable Solution D1/AS1.

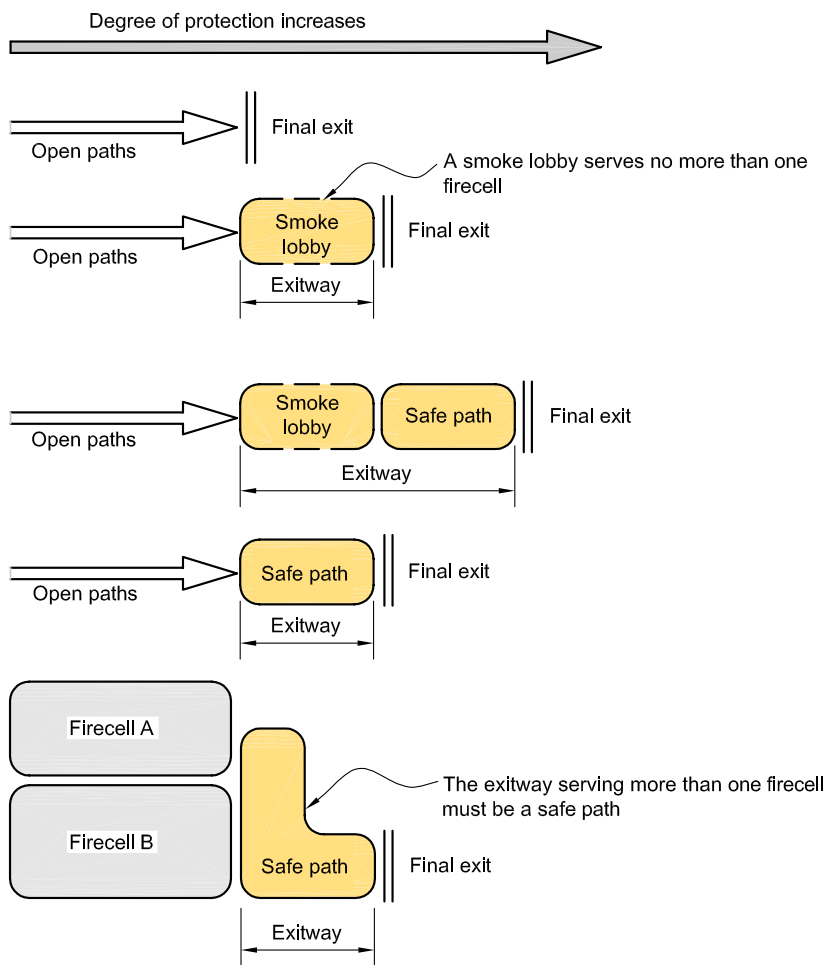
Amend 2  
Nov 2020

### 3.2 Number of escape routes

**3.2.1** Except where Paragraph 3.13 allows the use of single escape routes, every occupied space in a building shall be served by two or more escape routes (see Figure 3.2).

**3.2.2** The minimum number of escape routes from a floor level, except in those situations where single escape routes are permitted (see Paragraph 3.13), shall be in accordance with Table 3.1.

**Figure 3.1** Escape routes  
Paragraphs 3.1.1 and 3.1.2



Note:  
The *final exit* is where the *escape route* enters a *safe place*. This might be beyond the exit door from the *building*.

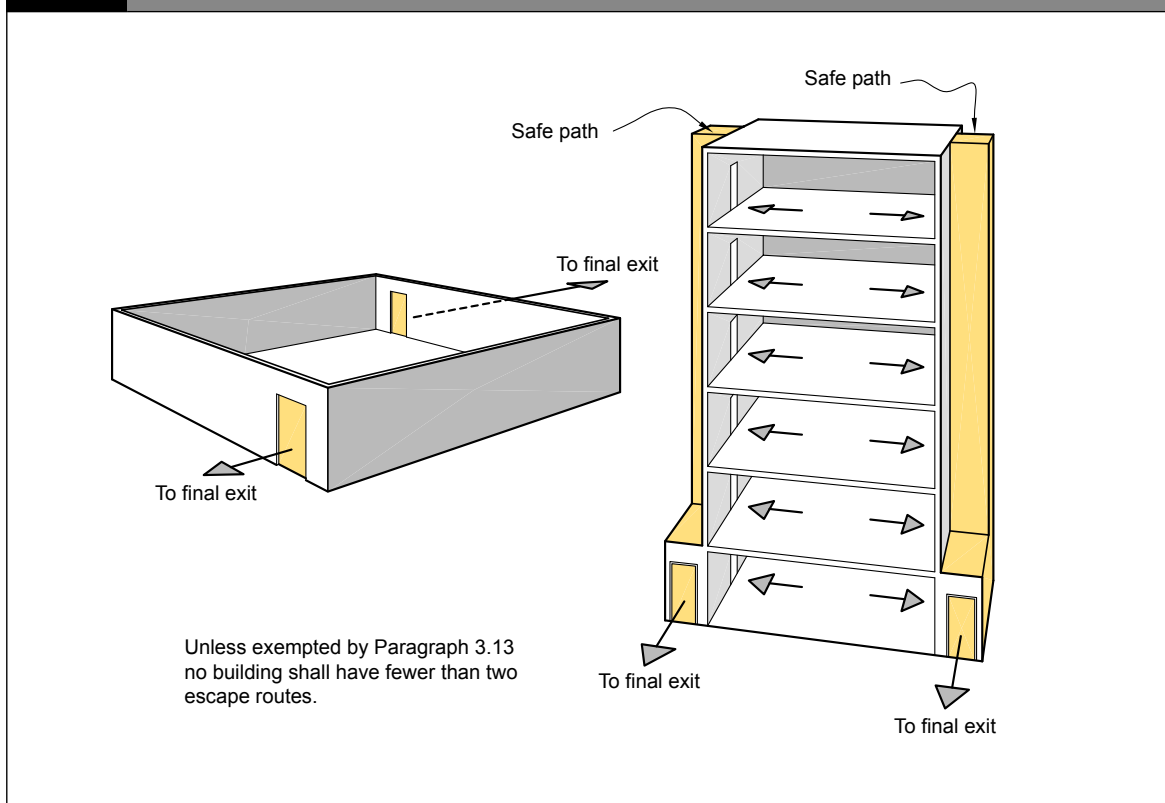
Table 3.1		Minimum number of escape routes from a floor level or firecell									
Risk group	Number of occupants										
	≤50	51-100	101-150	151-200	201-250	251-300	301-500	501-1000	1001-2000	2001-4000	4001-7000
SM	1*	2	3	3	4	4					
SI	2	3	3	4	4						
CA	1*	2	2	2	2	2	2	3	4	5	6
WB	1*	2	2	2	2	2	2	3	4	5	6
WS	1*	2	2	2	2	2	2	3	4	5	
VP	1*	2	2	2	2	2	2	3	4	5	6

**Note:**  
\* Refer to Paragraphs 3.13.1 to 3.13.6 for limitations.

Table 3.1a		Minimum clear width of escape routes, excluding ladders (mm) Paragraphs 3.3.2 and 3.15.5			
Risk group	Element	Open path <sup>1</sup>		Exitway	
		Horizontal	Vertical	Horizontal	Vertical
SM	Escape Route	850	1000	1000	1000
	Door	760	760	875	875
SI	Escape Route	850 <sup>2</sup>	1000	1200	1500
	Door	760 <sup>2</sup>	760	950	1200
CA WB WS VP	Escape Route	850	1000	1000	1000
	Door	760	760	875	875

**Notes:**  
1. *Escape route* widths may be reduced for single *escape routes* as permitted by Paragraph 3.3.2c) ii).  
2. Additional minimum clear widths are provided in Paragraph 3.15.5 a) and f) where the movement of beds is required.

**Figure 3.2** Minimum number of escape routes  
Paragraph 3.2.1



### 3.3 Height and width of escape routes

#### Height

3.3.1 Height requirements within *escape routes* shall be as follows:

- The clear height shall be no less than that required by D1/AS1, and
- Any door opening within, or giving access to, any *escape route* shall have a clear height of no less than 1955 mm for the required width of the opening.

#### Width

3.3.2 *Escape route* widths shall be in accordance with Table 3.1a and the following requirements:

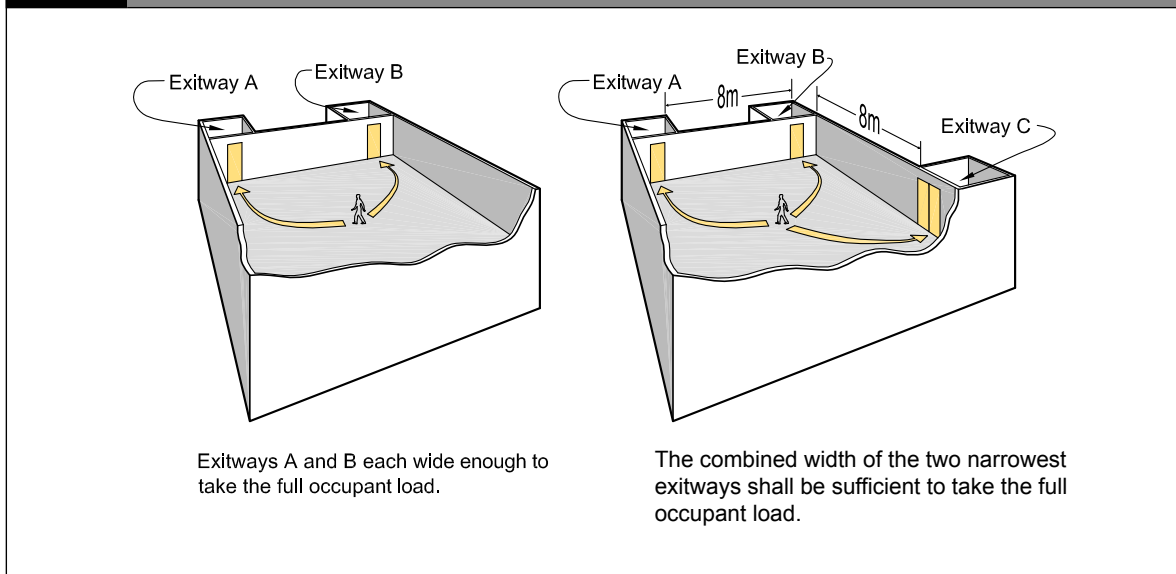
- Width of all available escape routes:** the total combined width of all available *escape routes* shall allow 7 mm/person for horizontal travel and 9 mm/person for vertical travel.

**SI** For *risk group SI* the total combined width of all available *escape routes* shall allow 8 mm/person for horizontal travel and 10 mm/person for vertical travel.

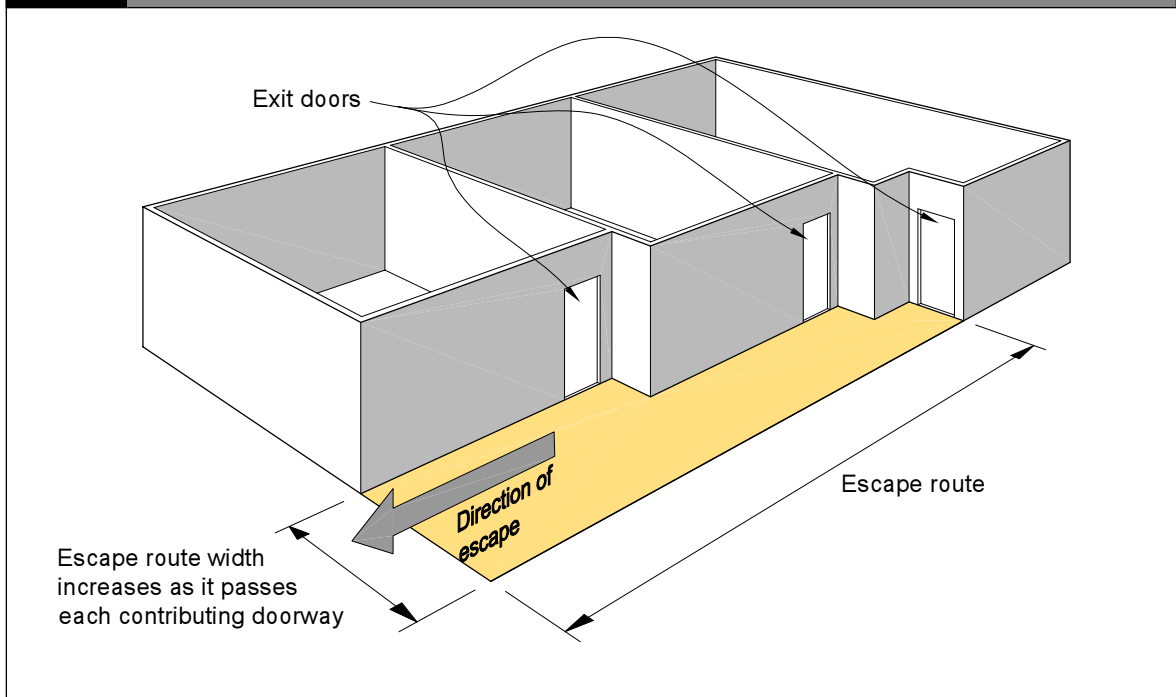
- SI** **b) Width of individual escape routes for risk group SI:** these shall be no less than 1200 mm for horizontal travel, and 1500 mm for vertical travel. See Paragraph 3.15.5 for widths of doors required for the passage of beds.
- c) Width of individual escape routes:** these shall have a minimum width of 850 mm for horizontal travel and 1000 mm for vertical travel, except in the following cases:
  - if an *escape route* is within an *exitway*, its width shall be no less than 1000 mm, and
  - if an *escape route* is within an *open path* and a single *escape route* is permitted, its width may be reduced to 700 mm for horizontal travel and 850 mm for vertical travel.

- d) **Provision for unusable escape routes:** except where *dead ends* and single *escape routes* are permitted, in unsprinklered *firecells* the total required width shall still be available should the widest of the *escape routes* be unusable due to the location of the *fire* or any other reason (see Figure 3.3).
- e) **Sprinkler concession:** if the *firecell* is sprinklered, requirement d) does not apply (i.e. it is not necessary to provide extra width to allow for the possibility that one *escape route* may be unusable).
- f) **Horizontal escape route with a single direction of escape:** this shall be wide enough at any point to take the full *occupant load* from all contributing *occupied spaces*. However, the *escape route* may have its width increased progressively as it passes the exit from each *occupied space* (see Figure 3.4).
- g) **Horizontal escape route with two directions of escape:** this shall have sufficient width for the full length of the route to allow for the *occupant load* from all contributing *occupied spaces*. However, this shall not apply if the requirements of Paragraph 3.7.14 e) are met for escape through adjacent *firecells*.
- h) **Intermediate floors:** for *firecells* containing an *intermediate floor*, both the vertical and horizontal parts of the *open path escape route* shall be wide enough to take the full *occupant load* from all contributing *occupied spaces*.
- i) **Vertical safe path widths:** Vertical *safe paths* shall have minimum widths at any point determined only by the largest total *occupant load* passing that point in the direction of escape from:
- i) any single level (where not part of an *intermediate floor firecell*)
  - ii) all levels in a *firecell* where it spans more than one level.
- SM CA** j) **Marae buildings using traditional Māori construction materials in risk groups SM and CA:** where applying the exception permitted in Paragraph 4.17.6 i), the *escape route* widths required by Paragraph 3.3.2 shall be doubled.
- k) **Basements:** if an *escape route* from upper floors is joined at the level of a *final exit* by an *escape route* from a *basement* or lower floors, the *escape route* width at the point they combine shall be increased to accommodate the *occupant loads* from both directions (see Figure 3.5).
- l) **Ladders:** the width requirements of Paragraph 3.3.2 c) do not apply to ladders where their use is permitted in this Acceptable Solution.
- CA** m) **Fixed or loose seating in risk group CA:** the width requirements of Paragraph 3.3.2 a) to e) do not apply to fixed or loose seating.

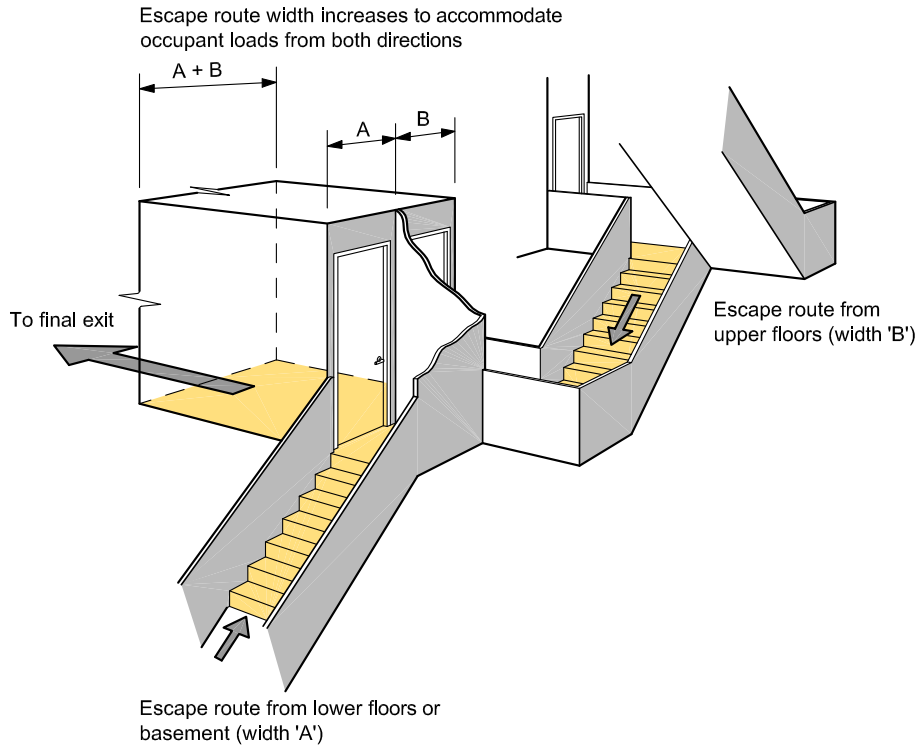
**Figure 3.3** Exitway widths in unsprinklered firecells  
Paragraph 3.3.2 d)



**Figure 3.4** Increase in width for horizontal escape routes having a single direction of escape  
Paragraph 3.3.2 f)



**Figure 3.5** Escape routes from lower and upper floors  
Paragraph 3.3.2 k)





### Handrails and limitations to stairway widths

**3.3.3** For safe evacuation on stairs, all *stairways* shall have at least one *handrail*. Furthermore:

- a) *Stairways* in *escape routes* wider than 1500 mm shall have *handrails* on both sides, and
- b) *Stairways* in *escape routes* wider than 2000 mm (see Figure 3.6) shall also be provided with intermediate *handrails* which are equally spaced and which provide a width not greater than 1500 mm for each section of the *stairway*.

**3.3.4** If the *escape height* exceeds 35 m, no more than 1500 mm shall be credited to the width of any *stairway* when calculating *stairway* capacity for an *escape route*.

### Curved and spiral stairs

**3.3.5** Where curved or spiral stairs form part of an *escape route*, the required width of such stairs is to be measured across the tread where the tread depth meets the requirements for the tread depth in Acceptable Solution D1/AS1.

Amend 2  
Nov 2020

### Obstructions

#### 3.3.6

The following minor obstructions are acceptable within the width of an *escape route*:

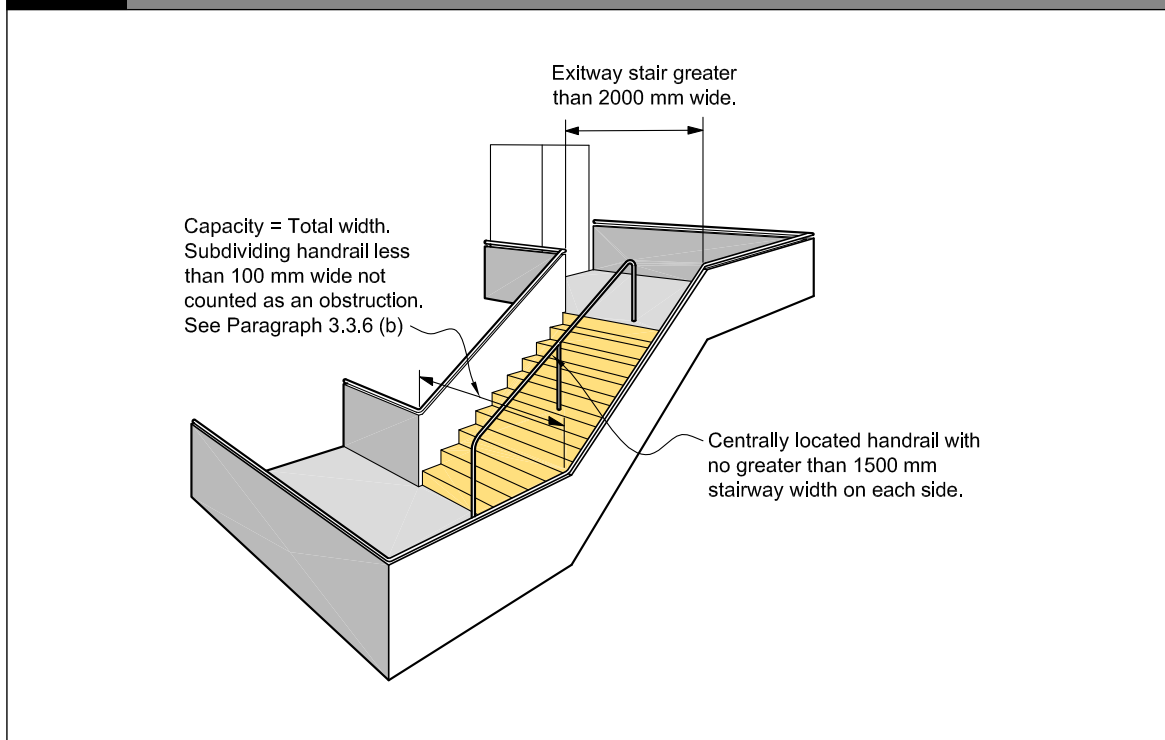
- a) **Minor projections** complying with the requirements of Acceptable Solution D1/AS1 such as signs, switches, alarm sounders and similar projections, and
- b) **Handrails** complying with Acceptable Solution D1/AS1 and projecting no more than 100 mm into the width, and *handrails* subdividing wide *stairways* that reduce the width by no more than 100 mm (see Paragraph 3.3.3), and
- c) **Door assemblies** which reduce the width of an *exitway* by no more than 125 mm when the door is fully open (see Figure 3.23), or as permitted by Table 3.1a, and
- CA** d) In **risk group CA** fixed seating (at the start of an *escape route*) which complies with the requirements of Paragraph 3.7.4 and Table 3.3 for the width of aisles and space between rows.

**3.3.7** Except as permitted by Paragraph 3.15.7, *escape routes* shall not be obstructed by access control systems.

Amend 2  
Nov 2020

Amend 2  
Nov 2020

**Figure 3.6** Limitations to stairway widths  
Paragraph 3.3.3 b)



### 3.4 Length of escape routes

**3.4.1** An *escape route* may be any length, but:

- a) The lengths of *dead ends* and total *open paths* shall not exceed the distances given in Table 3.2, adjusted as necessary for:
  - i) reductions on *intermediate floors* (see Paragraph 3.4.3), apart from **risk group VP firecells** with adequate cross ventilation in accordance with Paragraph 4.1.3, and
  - ii) reductions on stairs and ladders (see Paragraph 3.4.4), and
- b) If the distance to the *final exit* exceeds the allowable length for total *open paths*, the remainder of the *escape route* shall be a *safe path* (see Paragraph 3.9.7 for *safe path* length restrictions within a single floor level).

### Open paths

**3.4.2** When determining *open path* lengths, including any *dead end*, the following shall apply:

- a) **Start point:** the length shall be measured from no more than 1.0 m from the most remote point in a space.
- b) **Multiple risk groups:** the lengths specified in Table 3.2 shall apply to all *risk groups*. When other *risk groups* with different allowable maximum *open paths* lengths use the same *open path*, the *open path* length for the *risk group* with the shortest maximum length shall apply.
- c) **Furniture and fittings:** allowance shall be made for the *travel distance* around obstructions such as furniture, fittings and office equipment located in the *open path* (see Figure 3.7(a)). If the location of such obstructions is not known, then the allowable *travel distance* shall be measured orthogonally (see Figure 3.7(b)).

- d) **Multiple escape routes:** if two or more *escape routes* are required, *open path* lengths from any point on a floor to no fewer than two exits from the *firecell* shall not exceed the lengths specified in Table 3.2.
- e) **Marae buildings using traditional Māori construction materials:** when applying the exception permitted in Paragraph 4.17.6 (i), the permitted length of the *open path* specified in Table 3.2 shall be halved.
- f) **Termination:** an *open path* ends either at:
  - i) the start of an *exitway*, or
  - ii) a *final exit*, or
  - iii) the point where the *escape route* passes into an adjacent *firecell* on the same level (see Paragraph 3.7.13).

### Intermediate floors

**3.4.3** On *intermediate floors* (see Figure 3.8), the *open path* length shall be taken as 1.5 times the measured length in accordance with Paragraph 3.4.2 c). However, the measured length may be used where the *intermediate floor* is a *smokecell* and an *escape route* is available from the *intermediate floor* without passing through any lower space in the same *firecell*.

### Stairs and ladders

**3.4.4** Stairs and ladders occurring in an *open path* (see Figure 3.9) shall have their *open path* length taken as:

- a) **For straight and curved stairs:** the plan length measured on the stair centreline multiplied by 1.2, plus the plan length of each landing,
- b) **For spiral stairs:** twice the vertical height, and
- c) **For ladders:** three times the vertical height.

### Sloping floors and ceilings

**3.4.5** The *open path* length permitted by Table 3.2 shall be reduced by 50% in any space where the following conditions apply:

- a) Both the floor and the ceiling slope in the same direction at an angle of more than 4° from the horizontal, and any *escape route* from the space is up the slope, and
- b) The clear ceiling height at any point is less than 4.0 m, and
- c) The *occupant load* in the space is more than 50, and
- d) The space is unsprinklered.

### Escape through adjoining building

**3.4.6** An *escape route* may be via an adjoining *building* (see Figure 3.10), provided the following conditions are satisfied:

- a) The *escape route* through the adjoining *building* meets all *escape route* requirements for the *occupant load* from the *fire affected building* requiring to use that route, and
- b) Unless the *escape route* passes directly to a *safe path* in the adjoining *building*, access shall be through a *smoke lobby* before passing through the *external walls*, and
- c) The opening through the *external wall* having the higher *FRR* has a *fire door* with an *FRR* of no less than that wall, and
- d) *Escape routes* in the adjoining *building* comply with the *Building Code* and have sufficient capacity to carry the *occupant load* from the *building* or *buildings* being evacuated, and
- e) The *escape route* does not re-enter the first *building* at any point, and is freely available at all times.

Table 3.2		Travel distances on open paths (metres) Paragraph 3.4									
Risk group	No system and Type 2 system		Type 3 system		Type 4 and Type 5* systems		Type 6 system		Type 7 system		
	Dead end open path	Total open path	Dead end open path	Total open path	Dead end open path	Total open path	Dead end open path	Total open path	Dead end open path	Total open path	
SM	20	50			30	75	30	75	40	100	
SI									20	50	
CA	20	50	20	50	40	100	40	100	50	120	
WB	25	60	35	75	50	120	50	120	75	150	
WS							50	120	75	180	
VP	35	90	45	110			70	180			

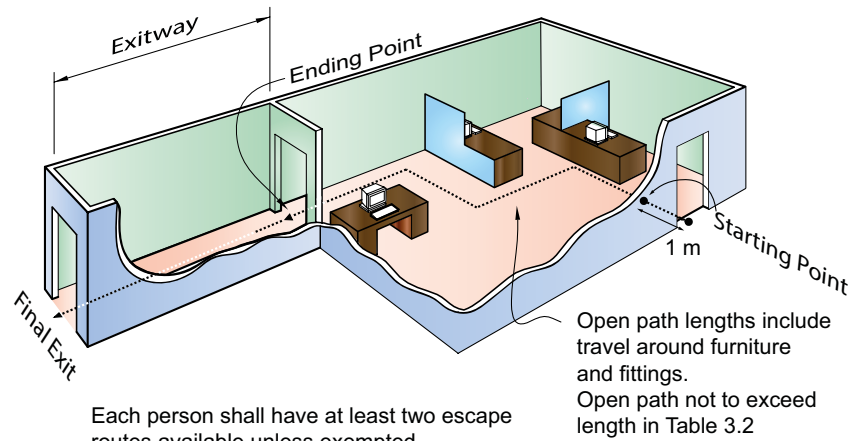
**Notes:**

If *open path* length increases for a Type 4 system are being applied, where Acceptable Solution F7/AS1 allows heat detectors to be substituted for smoke detectors, not less than 70% of the *firecell* shall be protected with smoke detectors.

If smoke and heat detection systems are installed in order to extend permissible travel distance in accordance with this table and are not a requirement of Paragraph 2.2.1 then Fire and Emergency New Zealand connection is not required.

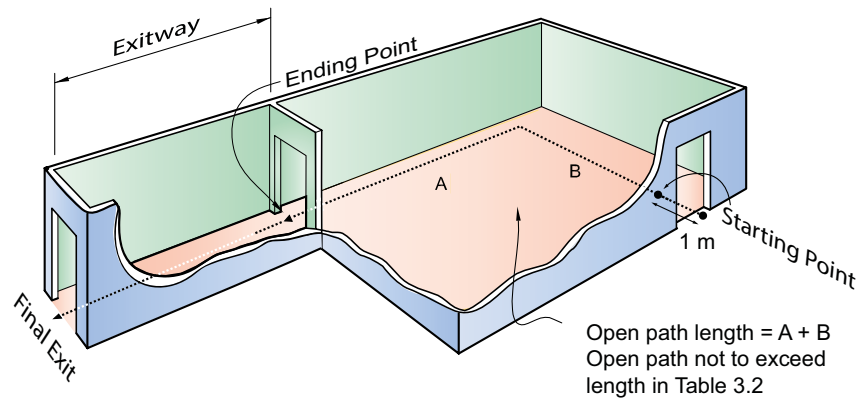
\* Type 5 system only for **risk group SM**.

**Figure 3.7** Length of open paths  
Paragraph 3.4.2



Each person shall have at least two escape routes available unless exempted by Paragraph 3.13

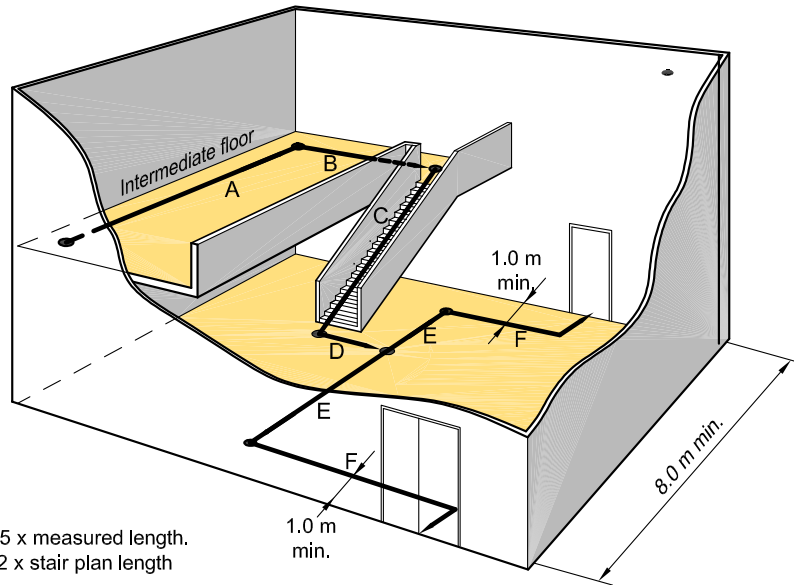
(a) FIXTURE AND FITTING POSITIONS KNOWN



(b) FIXTURE AND FITTING POSITIONS UNKNOWN

**Figure 3.8** Intermediate floor open path length  
Paragraph 3.4.3

Dead end route on intermediate floor assessed as 1.5 x measured length.

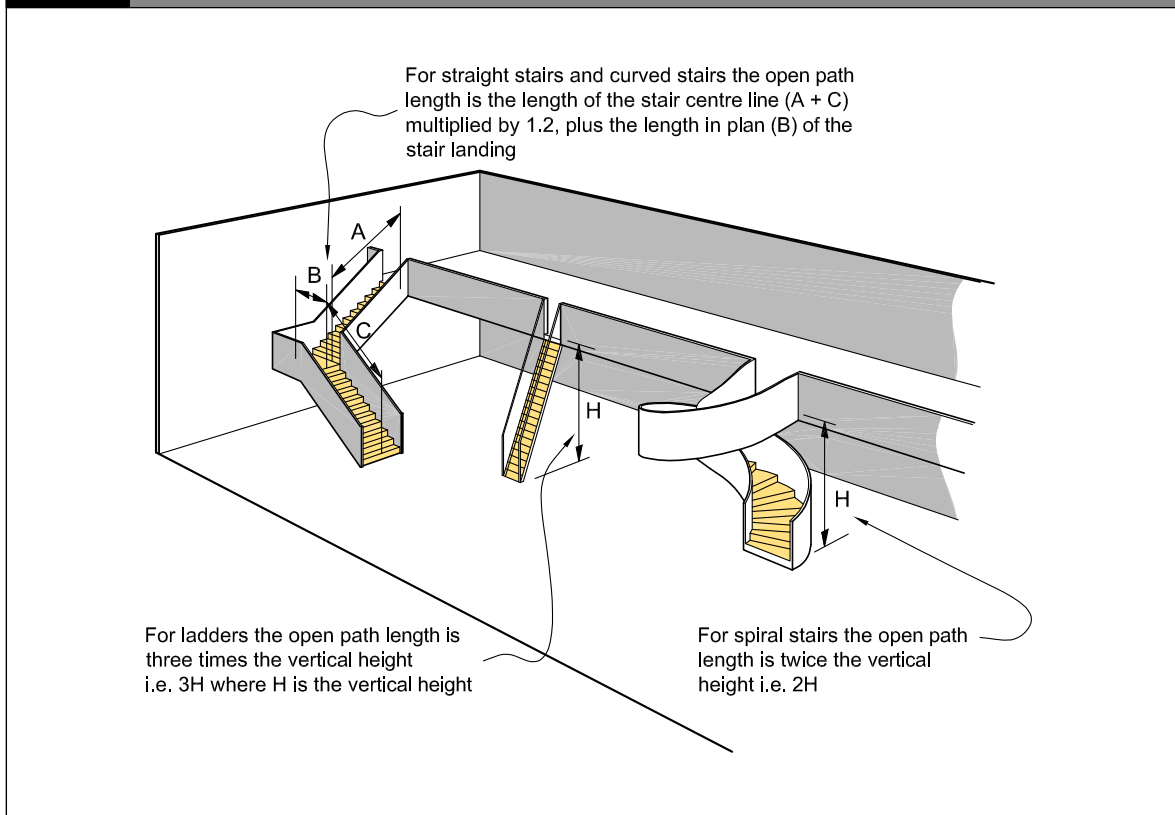


A + B = 1.5 x measured length.  
C = 1.2 x stair plan length

A + B + C + D must not exceed maximum permitted dead end length in Table 3.2.

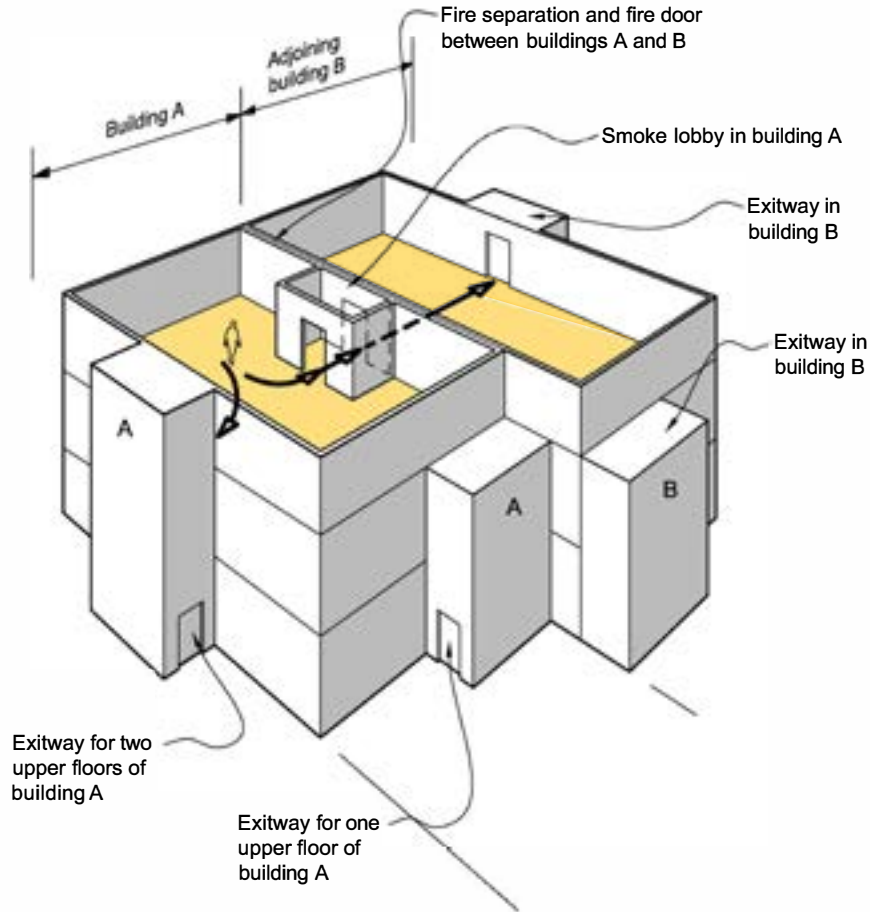
A + B + C + D + E + F must not exceed maximum permitted open path length in Table 3.2.

**Figure 3.9** Stairs and ladders  
Paragraph 3.4.4



Amend 2  
Nov 2020

**Figure 3.10** Escape through adjoining building  
Paragraphs 3.4.6 and 4.15.8 c)

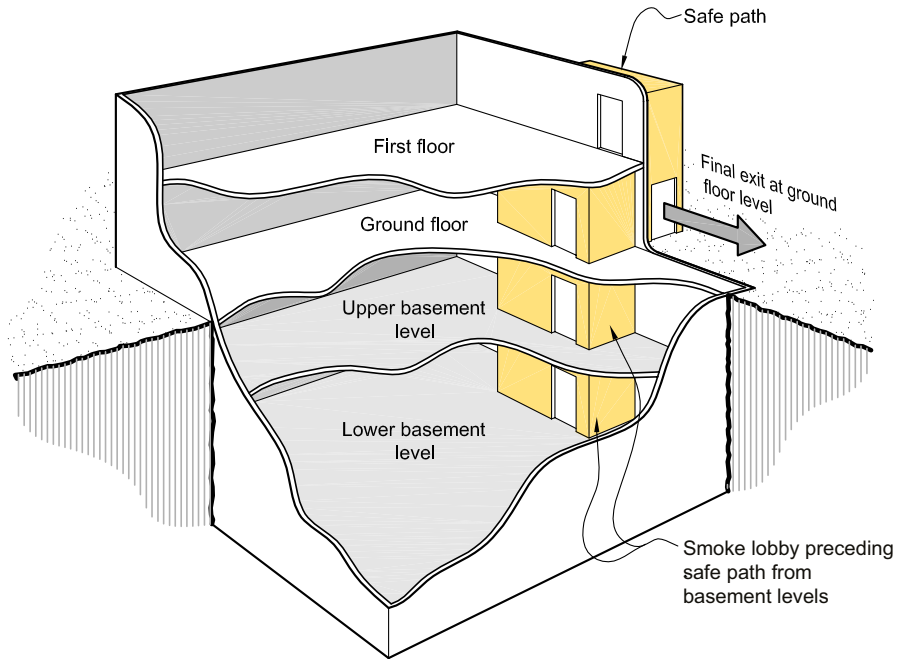


Amend 2  
Nov 2020



Amend 2  
Nov 2020

**Figure 3.11** Single escape from basement levels  
Paragraphs 3.5.1 and 3.13.1 d)



Amend 2  
Nov 2020

**NOTES:**

1. Occupant load at each basement level no greater than 50
2. A single *escape route* is permitted only when there are no more than two basement levels

### 3.5 Escape from basements

**3.5.1** Except in cases where there are two or more *escape routes* serving only the *basement firecells* and each terminates in a *safe place*, *safe paths* serving *basement firecells* shall be preceded by a *smoke lobby* that shall have a plan area in accordance with Paragraph 3.9.2 (see Figure 3.11).

### 3.6 Open paths

#### Number and size

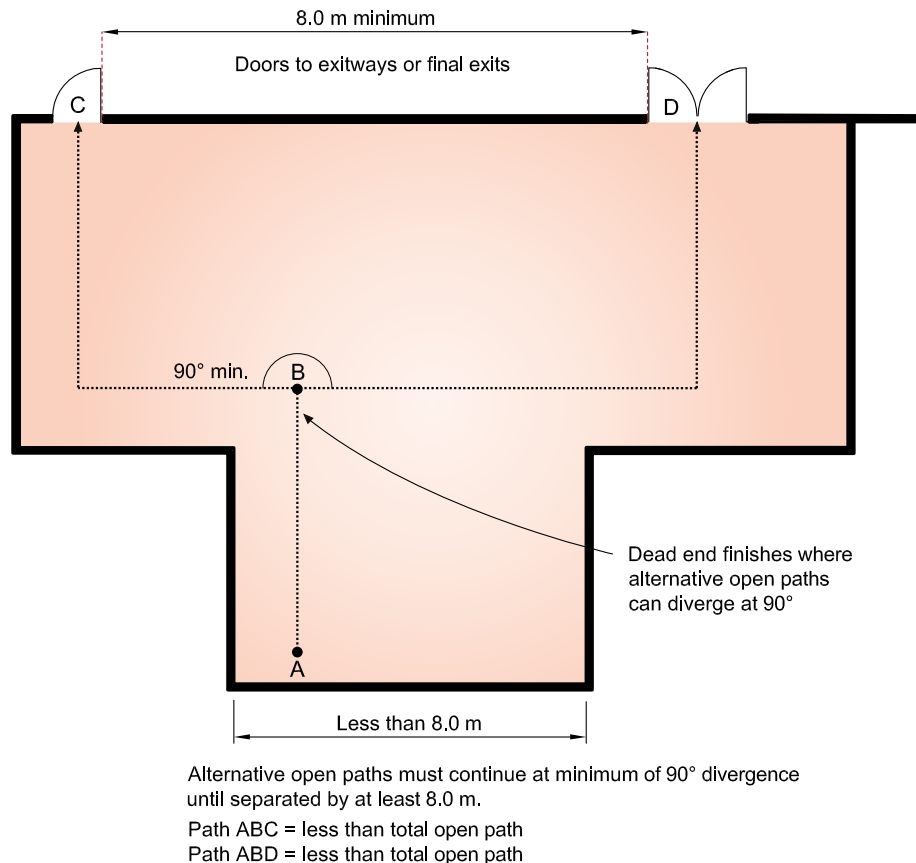
**3.6.1** *Open paths* shall satisfy the specific requirements of Paragraphs 3.6.2, 3.6.3 and 3.7 where they apply to a particular *building*.

#### Open path separation

**3.6.2** If two or more *open paths* are required, they shall be separated from each other, and remain separated until reaching an *exitway* or *final exit* (see Figure 3.12). Separation shall be achieved by diverging (from the point where two *escape routes* are required), at an angle of no less than 90° until separated by:

- A distance of at least 8.0 m, or
- Smoke separations* and *smoke control doors*.

**Figure 3.12** Alternative open path separation  
Paragraph 3.6.2



Amend 2  
Nov 2020

CA

**Exception for education buildings**

**3.6.3** If a *building* houses classrooms, laboratories and/or spaces used for home economics, art and crafts, workshops or similar teaching activities, one *open path* may be via a connecting corridor and the alternative *open path* may be via connecting doors between adjacent teaching spaces. In such cases, the separation requirements of Paragraph 3.6.2 need not apply provided that:

- The number of occupants in each teaching space does not exceed 100, and
- The *escape route* does not pass through a space which may be locked.

**3.7 Special cases of open paths****Passing into an adjacent firecell**Amend 2  
Nov 2020

**3.7.1** If an *escape route* passes through a number of *fire separations* it is permitted to continue as an *open path* provided the cumulative *travel distance* does not exceed the permitted distance specified in Table 3.2.

Amend 2  
Nov 2020

**3.7.2** An *open path* may pass into an adjacent *firecell* on the same level (see Figure 3.15) and recommence as a new *open path* provided that:

- All *firecells* on the *escape route* have no fewer than two directions of escape, separated as required by Paragraph 3.6.2, and

b) Adjacent *firecells* into which evacuation may take place have an available floor area to accommodate not only their own occupants, but also the occupants from the adjacent *firecell*. This shall be calculated on the basis of the *occupant load* of the two *firecells* with not less than 1.0 m<sup>2</sup> of space provided for each occupant. Refer to Paragraph 4.6.2 for additional requirements for **risk group SI**, and

- Each *firecell* has at least one other *escape route* independent of the route into the adjacent *firecell*. This other route may be by way of a *final exit* or via a third *firecell* provided that the exit from that third *firecell* is independent of exits from the other two *firecells*, and
- The *escape route* does not pass through more than three *fire separations* before entering an *exitway* or *final exit*, and
- The *escape route* width meets the requirements of Paragraph 3.3.2 for the *firecell* on the *escape route* that has the greatest *occupant load*.

**Separate tenancy**

**3.7.3** *Open paths* shall only pass through spaces containing different tenancies if doors leading to an *exitway* or *final exit* can be readily opened by all persons for whom the *open path* is their *escape route*

Amend 2  
Nov 2020Amend 2  
Nov 2020

Table 3.3 Walkways in fixed seating Paragraph 3.7.6		
Minimum walkway width (mm)	Maximum number of seats in any row	
	One aisle	Aisles both sides
300	7	14
340	9	16
380	9	18
420	10	20
460	11	22
500	12	24

### Escape via an intermediate floor

Amend 2  
Nov 2020



**3.7.4** For all **risk groups excluding SI**, an *open path* may pass from a *firecell* on to an *intermediate floor* and recommence as an *open path* provided that:

- a) Where two or more *escape routes* are required from that *firecell*, only one *escape route* shall be via the *intermediate floor*, and
- b) The *intermediate floor open path* length shall not exceed the requirements of Paragraph 3.4.3, and
- c) The *intermediate floor* is served by at least two *escape routes*, separated as required by Paragraph 3.6.2, and terminating at any of the following:
  - i) separate *firecells*,
  - ii) separate *exitways*, or
  - iii) *final exits*.

### Open paths via unenclosed stairs

Amend 2  
Nov 2020



**3.7.5** In **risk group SM**, unenclosed stairs (stairs which are not *smoke separated* or *fire separated* from other spaces) in *escape routes*, other than those within a *household unit* or *suite*, shall not exceed a height of 4.0 m within the *firecell*. Where the height exceeds 4.0 m, the *escape route* from that level shall be a *safe path* until it reaches a *final exit*.

### Fixed seating

Amend 2  
Nov 2020

**3.7.6** Fixed seating (except for within *household units* or *suites*) which includes seating that is moveable or foldaway, shall be arranged so that:

- a) Direct access to the aisles is available, and
- b) The number of seats in a row is no greater than that specified in Table 3.3, and
- c) The clear walkway width between rows is no less than that specified in Table 3.3, and
- d) The area occupied by each seat plus the walkway in front of it has a total dimension of at least 760 mm from seat back to seat back measured horizontally at right angles to the rows of seats (see Figure 3.13). The seat width must be at least:

- i) 500 mm where arms are provided (see Figure 3.13), and
- ii) 450 mm where arms are not provided.

### Loose seating

**3.7.7** Except for within *household units* or *suites*, loose seating is permitted only on level floors. The layout shall follow the requirements of Paragraphs 3.7.9 to 3.7.14.

**3.7.8** Where the number of seats exceed 250, loose seating shall be interconnected to prevent overturning.

### Aisles

**3.7.9** Except within *household units* or *suites*, aisles serving fixed or loose seating (see Figure 3.14) shall provide access to *final exits* or *escape routes*. The width of the *final exits* or *escape routes* shall be the greater of the:

- a) Aisle width as required by Paragraph 3.7.10, or
- b) Width required by Paragraph 3.3.2.

**3.7.10** Aisle widths shall be no less than:

- a) 750 mm when serving up to 60 seats,
- b) 900 mm when serving over 60 seats on one side only, or
- c) 1100 mm in all other cases.

The minimum width shall occur at:

- d) If discharge is in one direction only, the point furthest from the exit door in aisles, or
- e) If discharge is in two directions, the mid-length of an aisle to separate cross-aisles or to separate exit doors.

There is nothing to prevent an aisle being made wider than the minimum required. However, to avoid restrictions, this shall be done only in the direction of travel.

**3.7.11** Each cross-aisle shall have a width of no less than that of the widest aisle it serves plus 50% of the sum of the widths of all other aisles served.

**3.7.12** The *travel distance* from any seat to an adjacent *firecell*, a *final exit*, or *exitway* shall be no greater than allowed for an *open path* in Table 3.2. If there are sloping ceilings and floors, refer to Paragraph 3.4.5 for further restrictions.

Amend 2  
Nov 2020

Amend 2  
Nov 2020

Amend 2  
Nov 2020

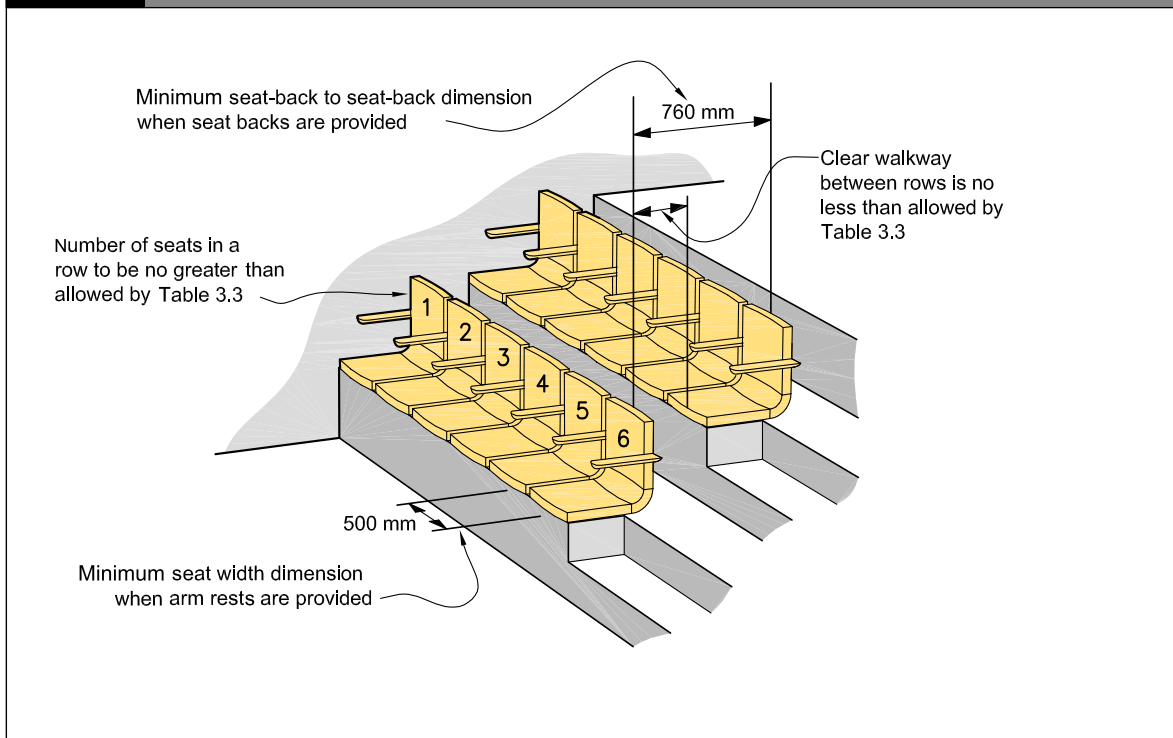
Amend 2  
Nov 2020

Amend 2  
Nov 2020

Amend 2  
Nov 2020

Amend 2  
Nov 2020

**Figure 3.13** Fixed seating – with backs  
Paragraph 3.7.6 d)



Amend 2  
Nov 2020

**3.7.13** Any side of an aisle that does not provide access to seating shall have barriers complying with Acceptable Solution F4/AS1 and *handrails* complying with Acceptable Solution D1/AS1.

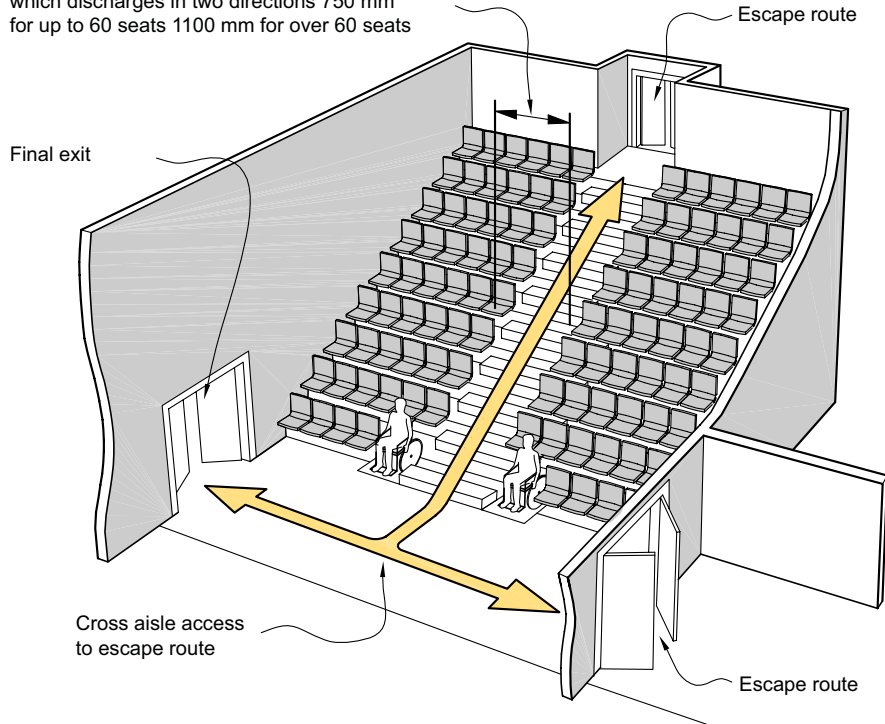
Amend 2  
Nov 2020

**3.7.14** Steps in aisles shall have consistent riser heights and tread depths, both complying with the requirements of Acceptable Solution D1/AS1. Landing lengths in aisles shall be equal in each block of seating between cross-aisles, but may be less than the minimum length required by Acceptable Solution D1/AS1.

Amend 2  
Nov 2020

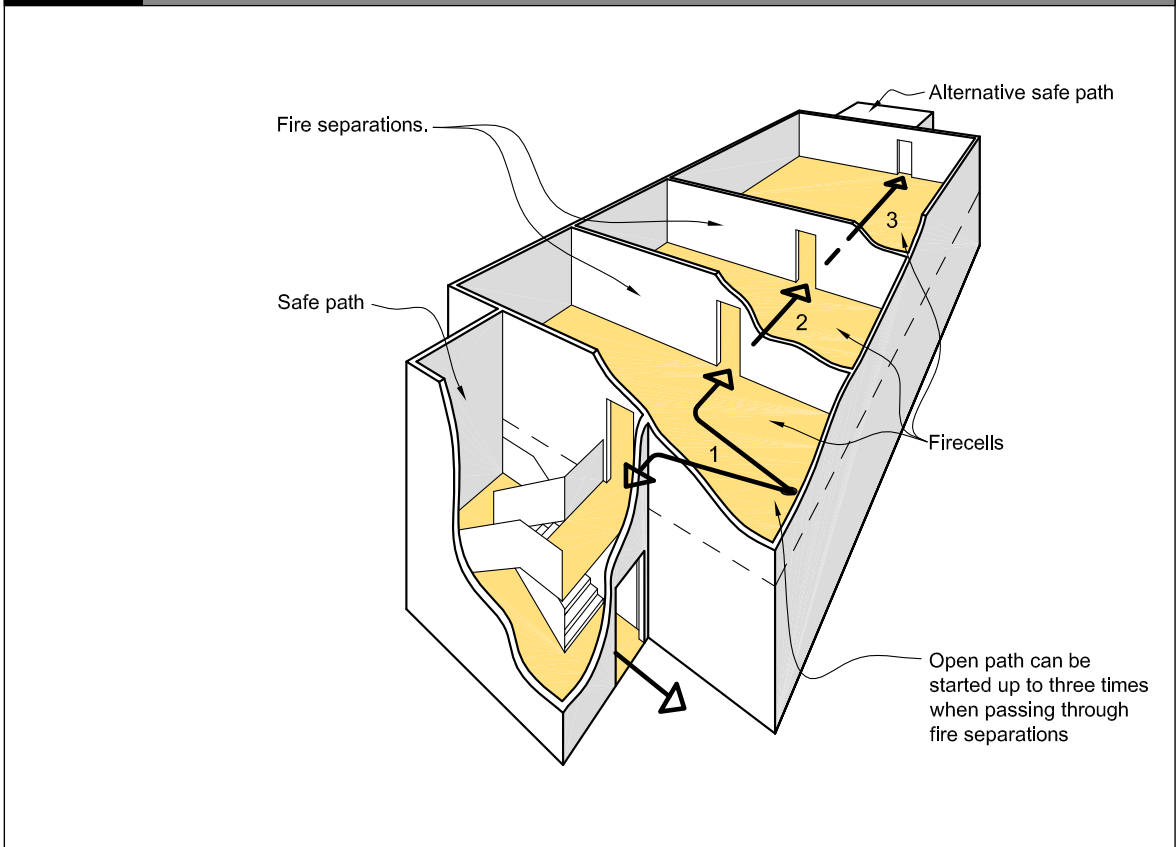
**Figure 3.14** Aisles serving fixed seating  
Paragraph 3.7.9

Minimum aisle width at mid-length of aisle,  
which discharges in two directions 750 mm  
for up to 60 seats 1100 mm for over 60 seats

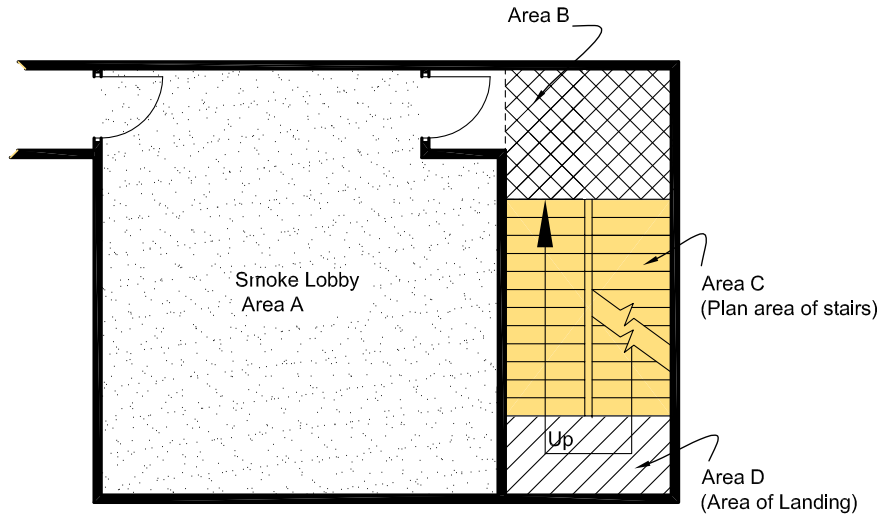


Amend 2  
Nov 2020

**Figure 3.15** Open path passing into adjacent firecells  
Paragraph 3.7.2



**Figure 3.16** Sizing of smoke lobbies  
Paragraph 3.9.2



Size of smoke lobby (Area A) required =  
Number of persons to be accommodated x 0.25 minus (Area B + Area C + Area D)  
The size shall be at least that required by D1/AS1

### 3.8 Dead ends

**3.8.1** A *dead end* terminates where the *escape route* reaches a point in the *open path* which offers alternative directions of travel, or at a *final exit* or an *exitway*.

Amend 2  
Nov 2020

#### No more than 50 occupants

**3.8.2** A *dead end* shall not serve an *occupant load* greater than 50.

Amend 2  
Nov 2020

#### Ladders

**3.8.3** For all **risk groups excluding SM and SI**, the *escape route* from a *dead end* may be a ladder complying with Acceptable Solution D1/AS1 if it serves only support activities or provides the same function in support of other *risk groups*, and only if the *occupant load* does not normally exceed four.

Amend 2  
Nov 2020



Ladders are not permitted as *escape routes* in any other circumstances (see also Paragraph 3.4.4).

### 3.9 Exitways

**3.9.1** *Exitways* consist of either: *smoke lobbies*, or *safe paths*, or both.

Amend 2  
Nov 2020

#### Smoke lobbies – floor area

**3.9.2** If a *smoke lobby* is required preceding a vertical *safe path* (see Paragraphs 3.5.1, 3.9.3 and 3.13.1 and Figures 3.11 and 3.16), its floor area shall be calculated for the *occupant load* using that *smoke lobby* and its size shall be at least that required by the doors and opening requirements of D1/AS1, on the basis that:

- a) Part of the *occupant load* will be accommodated in the vertical *safe path* between the level being considered and the next level in the direction of escape, with the remaining occupants accommodated in the *smoke lobby*, and



- b) The occupant density for calculating the required holding area shall be 0.25 m<sup>2</sup> per person. The usable floor area within the stairwell shall be taken as the area of the first landing, plus the plan area of the flights of stairs between the two floor levels, plus the areas of any intermediate landings. Additional space shall be provided for door swings.

### Smoke lobbies – exitways from upper and intermediate floors

**SM CA** 3.9.3 For **risk groups SM** and **CA**, entrances to vertical safe paths shall be preceded by *smoke lobbies* (refer to Paragraph 3.9.2 for the required area of the *smoke lobby*) except where:

- The *safe path* from an upper floor or *intermediate floor* serves only that floor, or
- The *firecell* is sprinklered, or
- The *occupant load* of the *firecell* is less than 150, or
- The vertical *safe path* is preceded by a horizontal *safe path*.

### Safe paths

3.9.4 *Escape routes* from *firecells* shall enter directly into a *safe path* or *final exit*, except where Paragraphs 3.7.13 and 3.7.14 permit *open paths* to continue from one *firecell* to another.

3.9.5 *Safe paths* shall be separated from each other, and from all spaces by:

- Fire separations*, or
- If they are external to the *building*, by distance or appropriate *construction* (see Paragraph 3.11).

**SI SM** 3.9.6 Except where the conditions for escape via an external *escape route* (see Paragraph 3.11) or successive *open paths* (see Paragraphs 3.7.1 and 3.7.2) apply, exit doors from **sleeping area firecells** shall open directly onto:

- A horizontal *safe path*, or
- A *final exit*.

### Safe path length restrictions

3.9.7 There is no limit on the length of a vertical *safe path*. Horizontal *safe paths* shall be no longer than specified in Table 3.4.

### Safe path termination

3.9.8 Horizontal *safe paths* shall terminate at any of the following:

- The entrance to an internal *stairway* which is a separate *safe path*, or
- An external balcony leading to either an open or enclosed *stairway*, or
- An opening in an *external wall* which enters on to a bridge leading to an open or enclosed *stairway*, or
- A *final exit*.

### Safe path separation, glazing and smoke separation

3.9.9 *Fire doors* with smoke control capability shall be provided where *open paths* and horizontal *safe paths* provide access to internal vertical *safe paths*.

3.9.10 Glazing in *safe paths* shall comply with the requirements of Paragraph 4.2.

**SI** 3.9.11 For **risk group SI** only, at least half the *safe paths* shall terminate in a *safe place* without being combined with an *escape route* from any other *risk group*.

Amend 2  
Nov 2020

### 3.10 Control of exitway activities

**3.10.1** Exitways shall not be used for:

- a) Any storage of goods, solid waste or solid waste containers, or
- b) Entry points to solid waste chutes, or
- c) The location of furniture or other *combustibles*, or
- d) Storage of cloaks or linen, or
- e) A cleaner's cupboard not *fire separated* from the *exitway*, or
- f) The location of an electrical switchboard or similar, or
- g) Any activity (other than as permitted by Paragraph 3.10.2).

**3.10.2** Some activities are permitted in an *exitway* if:

- a) An alternative *escape route* is available from all *firecells* served by the *safe path* in which the activities occur, and
- b) For *buildings*:
  - i) with an *occupant load* of not more than 500, where a Type 4 or 5 system is installed, or
  - ii) with an *occupant load* of more than 500 where a Type 7 system is installed, and
- c) The *escape route* is not impeded by the activity or the occupants involved in that activity, and
- d) Those activities:
  - i) are visible to users of the *exitway*, except in the case of sanitary fixtures, and
  - ii) are a *direct support function* of the *risk group* served by the *exitway*, and
  - iii) occupy a total floor area of not more than 6.0 m<sup>2</sup> except in the case of sanitary fixtures.

Amend 2  
Nov 2020

### Lifts

**3.10.3** A passenger lift, but not a goods lift, may be located in a vertical *safe path* containing a *stairway* provided the following conditions are satisfied:

- a) The lift shaft and all its openings are located entirely within a single *firecell* containing the vertical *safe path*, and
- b) Passenger access into and from the lift car takes place entirely within the *safe path*, and
- c) No other activity occurs within the vertical *safe path*, and
- d) The lift is provided with a machine room that is a separate *firecell*, and the openings for lift ropes through the *fire separation* are as small as practicable, and any *penetrations*, such as for electrical cables, are *fire stopped* (refer to Paragraph 4.4 for *fire stopping*).

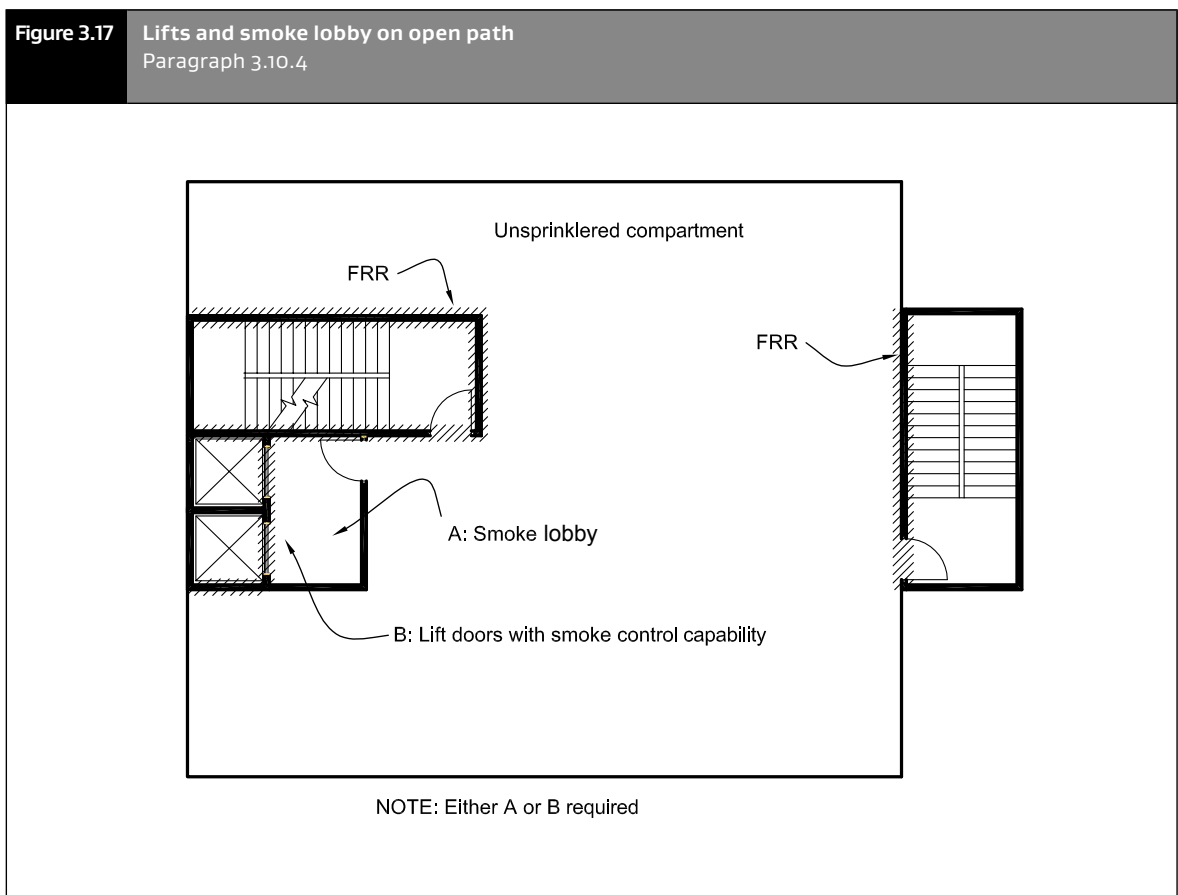
**3.10.4** Lift landings shall not open into or be located between *open paths* (see Figures 3.17 and 3.18) and shall either be provided with a *smoke lobby* separated from all other areas or have lift landing doors with smoke control capability. This requirement does not apply if the *building* is protected with a Type 7 system or the lift shaft has a pressurisation system designed to AS/NZS 1668.1. The lift doors shall be as specified in Paragraphs 4.16.3 and 4.16.11.

**3.10.5** In situations not described in Paragraphs 3.10.3 or 3.10.4, lift landings in unsprinklered *buildings* shall either open into a *smoke lobby* or the lift shaft shall be provided with a pressurisation system designed to AS/NZS 1668.1. Any *smoke lobby* shall not be part of the horizontal *safe path* (i.e. the horizontal *safe path* shall not pass through the *smoke lobby*). See Figure 3.18. The lift doors shall be as specified in Paragraphs 4.16.3 and 4.16.11.

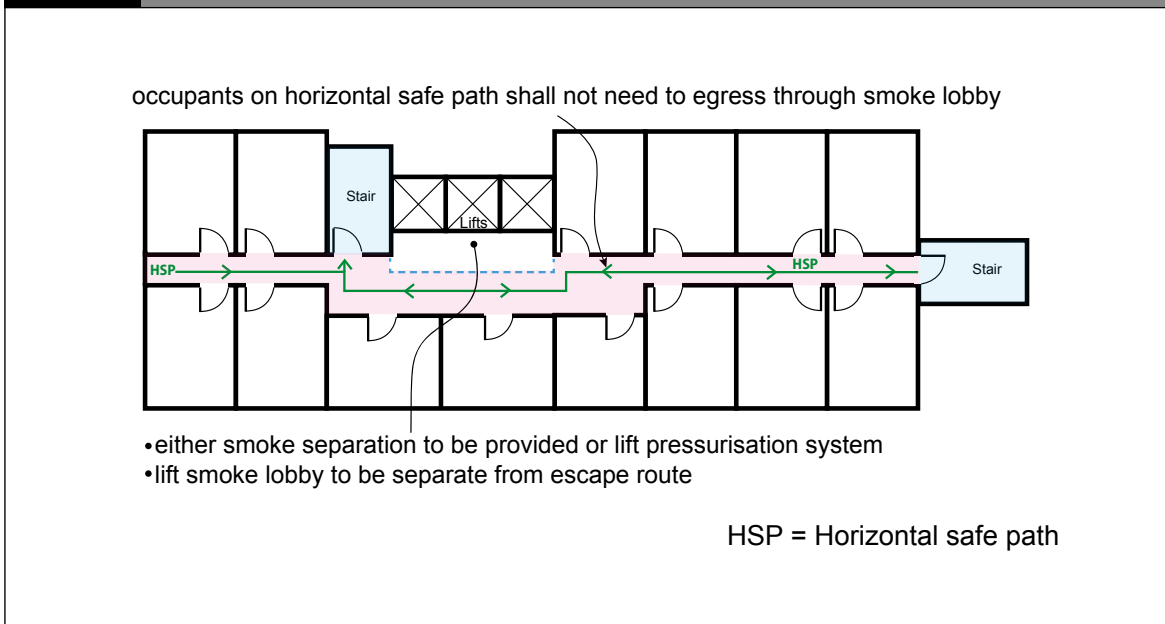
**Table 3.4** Travel distances on horizontal safe paths (metres)

Risk group	No system and Type 2 system		Type 3 system		Type 4 and Type 5 systems		Type 6 system		Type 7 system	
	Single direction	More than one direction	Single direction	More than one direction	Single direction	More than one direction	Single direction	More than one direction	Single direction	More than one direction
SM	25	180			40	Unlimited	40	Unlimited	50	Unlimited
SI									20	150
CA	20	150			40	Unlimited	40	Unlimited	60	Unlimited
WB	25	180			50	Unlimited	50	Unlimited	80	Unlimited
WS							50	Unlimited	75	Unlimited
VP	25	180	45	110			50	Unlimited		

**Notes:**  
 If *open path* length increases for a Type 4 or Type 7 system are being applied, where Acceptable Solution F7/AS1 allows heat detectors to be substituted for smoke detectors, not less than 70% of the *firecell* shall be protected with smoke detectors. It is not permitted to substitute the smoke detection in *exitways*.  
 If smoke and heat detection systems are installed in order to extend permissible *travel distance* in accordance with this table and are not a requirement of Paragraph 2.2.1 then Fire and Emergency New Zealand connection is not required.



**Figure 3.18** Lifts and smoke separations when landing on an unsprinklered horizontal safe path  
Paragraph 3.10.5



### 3.11 External escape routes

**3.11.1** If an *escape route* enters a space exposed to the open air (e.g. an open *stairway*, a balcony, across a roof or a ground level path), it shall meet the requirements of a *safe path* between that point and the *final exit*. *Safe path* separation requirements shall be achieved by providing either distance or *fire rated construction* between the *escape route* and *adjacent firecells*, as specified in Paragraphs 3.11.2 to 3.11.5.

#### Separation by distance

**3.11.2** Separation by distance shall be achieved as follows:

- If there is only one direction of escape, roofs and *external walls* shall not have *unprotected areas* closer to an external *escape route* than:
  - 2.0 m if unsprinklered (see Figure 3.19), or
  - 1.0 m if all *firecells* passed by the external *escape route* are sprinklered, or
- The *escape route* shall be located so that it diverges from *external walls* (see Paragraph 3.11.3), or

- Where alternative directions of escape are provided from the point where the *escape route* passes through an *external wall* and becomes an external *escape route* (refer to Paragraph 3.11.3 b)), *unprotected areas* are permitted.

Amend 2  
Nov 2020

Amend 2  
Nov 2020

Amend 2  
Nov 2020

Amend 2  
Nov 2020

Amend 2  
Nov 2020

**3.11.3** For an *escape route* which passes through an opening in an *external wall*, parts of the *external wall* need not be *fire rated* if:

- The direction of escape to a single *final exit* diverges from the *external wall* at an angle of no less than  $45^\circ$  in plan, or
- The directions of escape to alternative *final exits* diverge from each other at an angle of no less than  $90^\circ$  in plan and the *escape routes* subsequently do not both pass the same *firecell* (other than the *firecell* from which they originated), or
- Where *household units* and *suites* have full height glazing adjacent to a balcony which may be the only means of access and egress. The balcony shall provide the occupants with more than one *escape route* from the exit door, enabling them to escape without passing a unit containing a *fire*, or
- For shopfronts, if the *final exit* is onto the footpath it is not required to be *fire rated*.

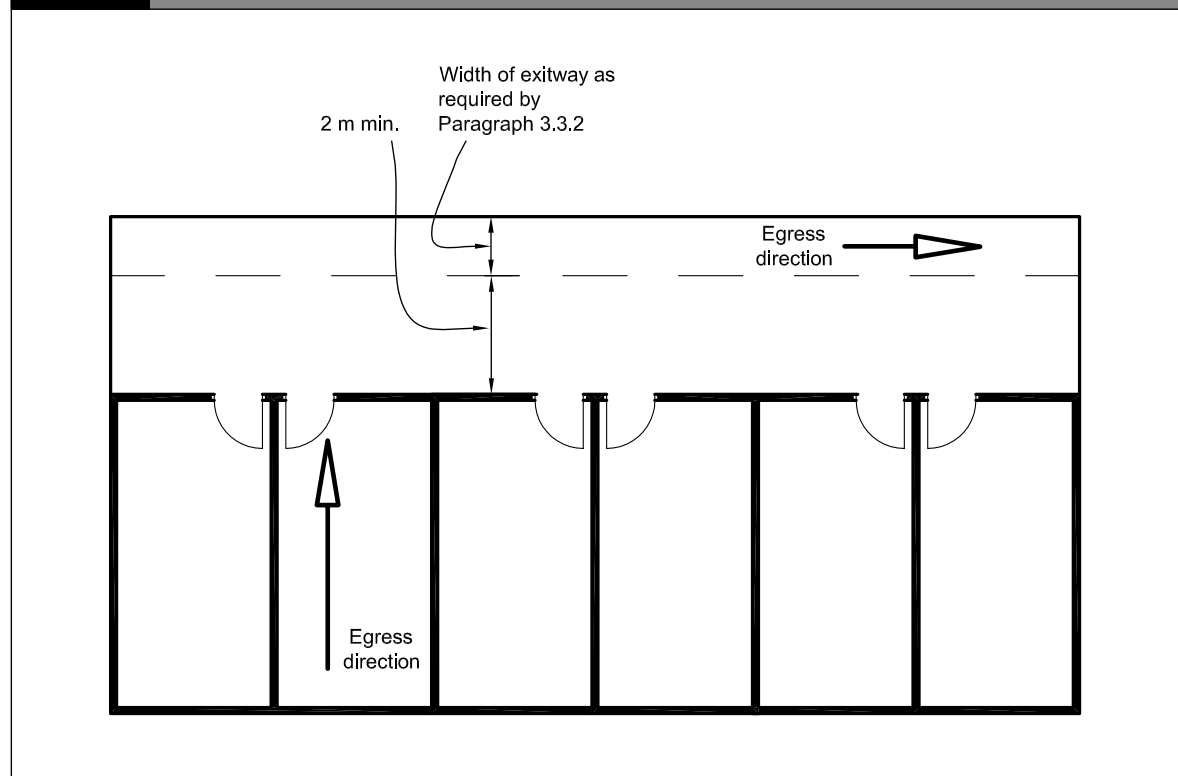
### Separation by fire rated construction

**3.11.4** Except where the separation distance requirements of Paragraphs 3.11.2 and 3.11.3 are achieved:

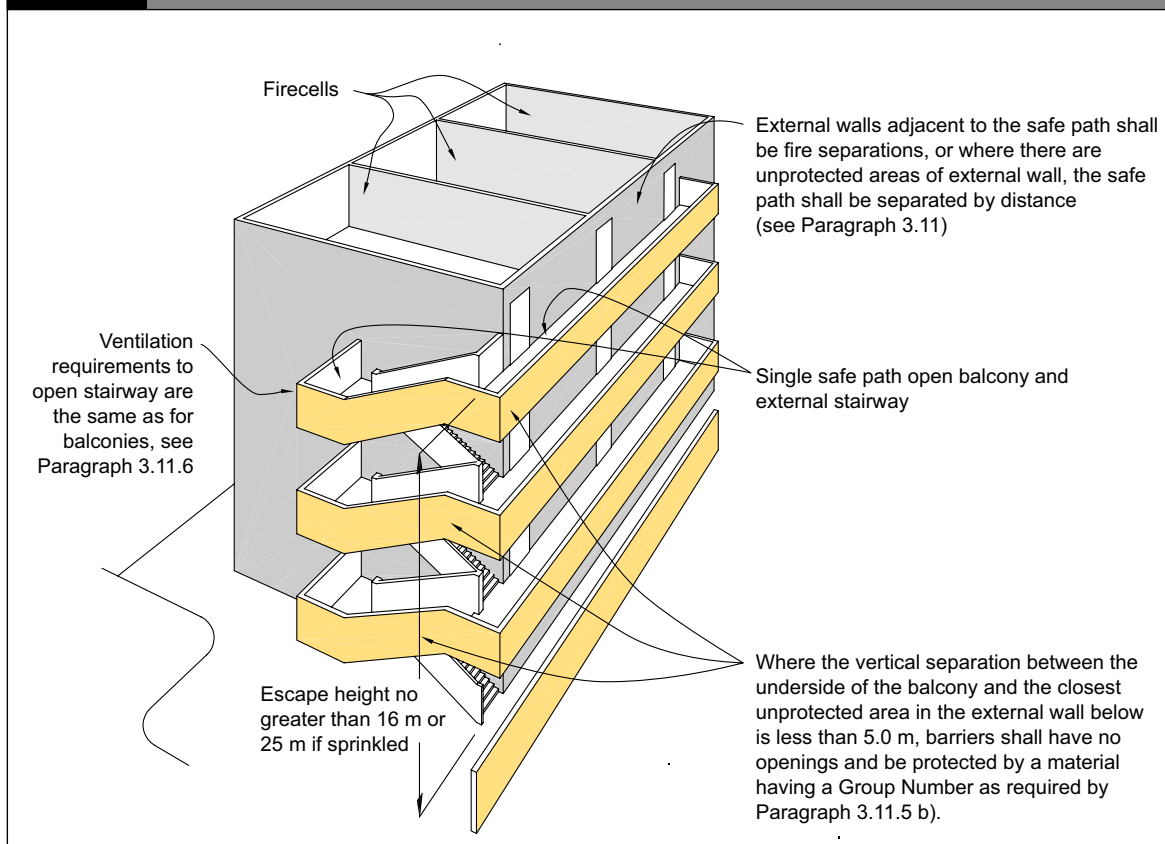
- External walls* and roofs adjacent to *external escape routes* shall comply with the *FRR* requirements of Paragraphs 5.3 and 5.7.3 to 5.7.5 and have no *unprotected areas*, except that glazing for *safe paths* complying with Paragraph 4.2 shall be permitted, and
- If the *escape route* is a balcony with a single direction of escape, and the vertical distance between the underside of the balcony and the closest *unprotected area* in the *external wall* below is less than 5.0 m (see Figure 3.20), balcony barriers shall:
  - have no openings, and
  - for **risk group SI** be protected with a material having a *Group Number* of 1, and
  - for all other **risk groups (SM, CA, WB, WS and VP)** achieve a *Group Number* no greater than 2, and

Amend 2  
Nov 2020

**Figure 3.19** Single external escape routes, unsprinklered building  
Paragraph 3.11.2(a)

Amend 2  
Nov 2020

**Figure 3.20** Single escape routes – direct access to balcony and stairway  
Paragraph 3.11.5



- c) If the vertical separation between the underside of an external *escape route* and *unprotected areas* in the *external wall* below is less than 5.0 m:
- i) the floor of an external *escape route* closer to an *external wall* than required by Paragraph 3.11.2 shall have an *FRR* of no less than required by Paragraph 2.3, and
  - ii) treads and risers of stairs on external *escape routes* shall either be constructed from a material which has a critical radiant flux of no less than  $2.2 \text{ kW/m}^2$  or shall be protected on the underside with a material having a *Group Number* of no greater than 2, and
- d) If a single *escape route* comprises external horizontal and internal vertical *safe paths*, a *smoke separation* shall be provided between them.

### Ventilation openings

**3.11.5** The open area of a balcony or bridge shall be no less than 50% of the balcony floor area, and shall be evenly distributed along the open sides and any approach ramp (see Figure 3.21). Where an *escape route* on a balcony is served by an open *stairway*, similar ventilation shall be provided on the *stairway*. Open sides shall not be enclosed, except that a fixed open grille may be used if it provides the required free air space.

### Open air auditoriums

**CA 3.11.6** For *risk group CA* open tiered seating decks shall:

- a) Have the number of *escape routes* required by Table 3.2 for the *occupant load*, and
- b) Comply with Paragraphs 3.7.4 to 3.7.12 for aisles and walkways between seats (Table 3.3 seat numbers are permitted to be doubled in this use), and

Amend 2  
Nov 2020

Amend 2  
Nov 2020

- c) Have *exitways* spaced at no more than:
  - i) 60 m apart where the space below the seating deck is required to be *fire separated* (see Paragraph 4.8.2), or
  - ii) 20 m apart where the space below requires no *fire separation*, and
- d) Be served by *escape routes* completely open to the air where the seating deck is not a *fire separation*.

**3.11.8** If the seating deck is required to be a *fire separation*, an *escape route* may pass through the deck and the space below, provided that part of the *escape route* is a *safe path* with an *FRR* in accordance with Paragraph 2.3.

## 3.12 Final exits

### Final exit separation

- CA** **WB** **VP** **3.12.1** For **risk groups CA, WB and VP**, *final exits* which open onto the same *safe place* shall be spaced no closer than 5.0 m centre to centre. This applies to both internal and external *exitways*.

## 3.13 Single escape routes

- SI** **3.13.1** Single *escape routes* shall only be permitted if:
  - a) The *dead end open path* length does not exceed the limits specified in Table 3.2, and
  - b) For all **risk groups excluding SI**, the total *occupant load* from all *firecells* on each level served by the *escape route* is no greater than 50, and
  - c) The *escape height* is no greater than:
    - i) 10 m if unsprinklered, or
    - ii) 25 m if sprinklered, and
  - d) There are no more than two *basement* levels and the vertical *safe path* from the *basement* levels is preceded by a *smoke lobby* (see Figure 3.11), and
  - e) In *buildings* with two or more floors, the vertical *safe path* is preceded by a *smoke lobby* on all floors except the topmost floor (refer to Paragraph 3.9.2 to determine the *smoke lobby* floor area).

Amend 2  
Nov 2020

Amend 2  
Nov 2020

### Risk group CA

- CA** **3.13.2** In **risk group CA**, a single *escape route* from the *firecell* is permitted provided that, in addition to the requirements of Paragraph 3.13.1, the number of preschool children per floor receiving child care (including those using workshops and dining rooms) is not greater than 10.

### Risk group WS

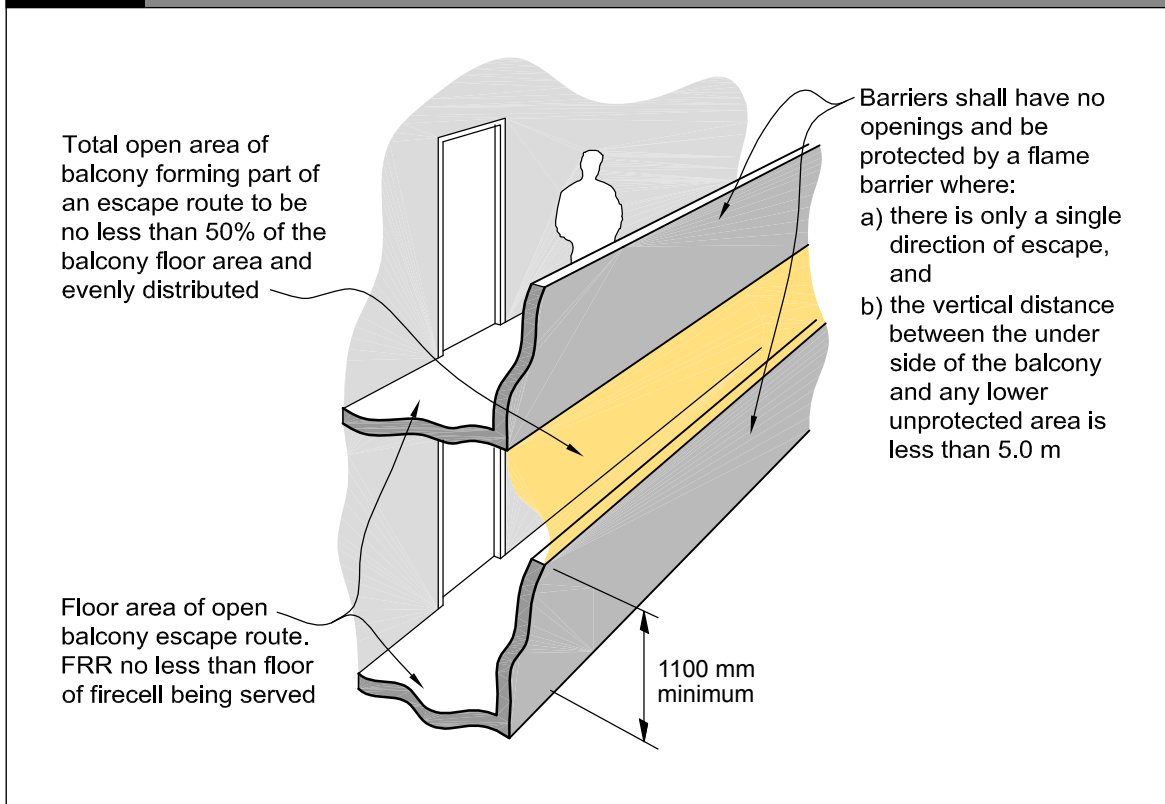
- 3.13.3** In **risk group WS**, a single *escape route* from the *firecell* is permitted provided that, in addition to the requirements of Paragraph 3.13.1, the *firecell* is on the ground floor.

### Risk group SM

- SM** **3.13.4** In **risk group SM**, a single *escape route* from a floor is permitted provided that, in addition to the requirements of Paragraph 3.13.1:
  - a) The number of *people with disabilities* on any floor is not greater than 10, and
  - b) The *escape route* within each *firecell* terminates at a *final exit* or opens onto a *safe path* which complies with the requirements of Paragraphs 3.9.4 to 3.9.11, and
  - c) The particular requirements for *stairways*, balconies and split level *exitways*, given in Paragraphs 3.7.3 and 3.13.5, are satisfied, and
  - d) The length of any *safe path* on a floor does not exceed the maximum *dead end* length permitted by Table 3.2.
- SM** **3.13.5** In **risk group SM**, balconies, bridges and external *stairways* (see Figure 3.20) may be part of a single external *escape route* where:
  - a) The *escape height* is no greater than 16 m if unsprinklered, or 25 m if sprinklered, and
  - b) The *escape route* on the balcony, bridge and *stairway* meets the requirements of Paragraph 3.11 for protection, *construction* and ventilation, and
  - c) The *external wall* within 3.0 m of the *stairway* is provided with an *FRR* in accordance with Paragraph 2.3, or the length of any bridge between the *external wall* and *stairway* is no less than 3.0 m.



**Figure 3.21** Open balconies  
Paragraph 3.11.5 and 3.11.6



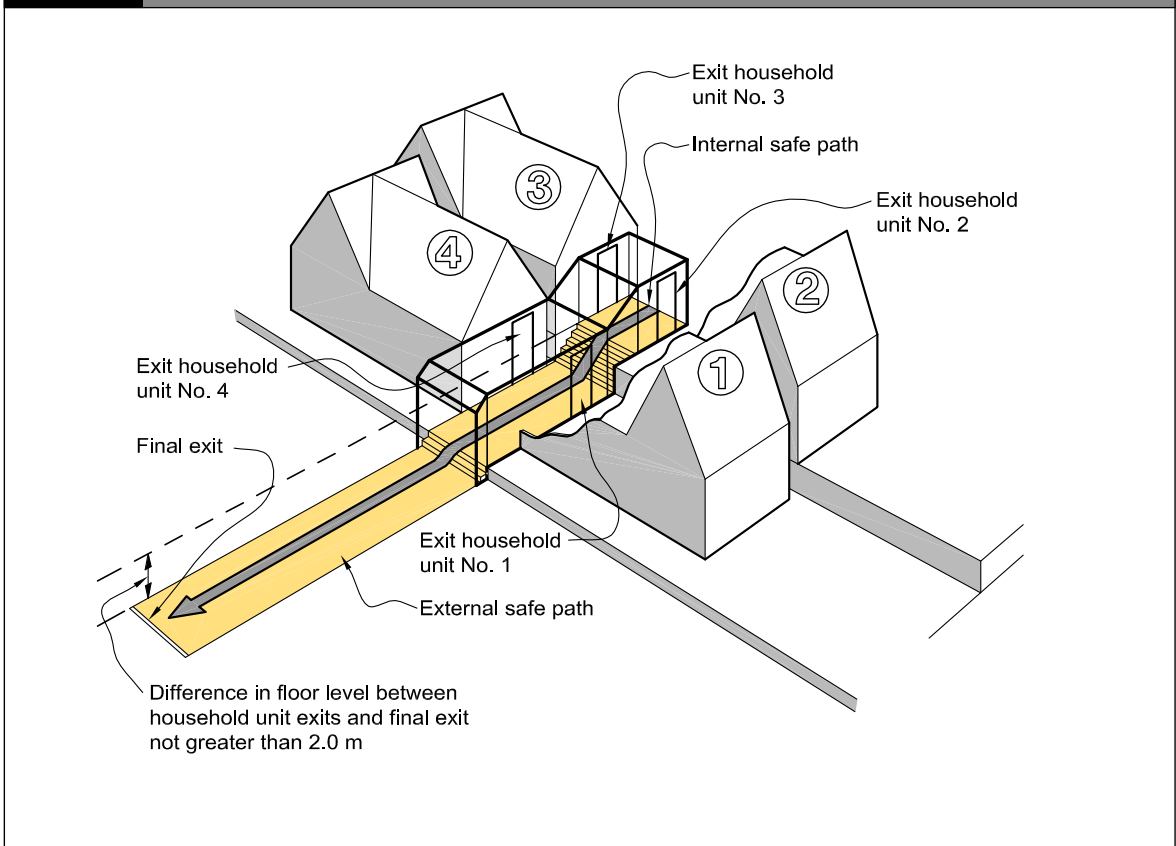
**SM** 3.13.6 In **risk group SM**, where a *building* is effectively of single storey *construction* but contains individual *household units* at slightly different levels (see Figure 3.22), a single internal *escape route* is permitted provided that:

- The *escape route* is a *safe path* leading directly to a *final exit*, and
- The difference in floor level between the *final exit* and any exit from a *household unit* is not greater than 2.0 m. The *safe path* is considered to be a horizontal *safe path* in this instance.

**SM** 3.13.7 In **risk group SM**, where the level difference is greater than 2.0 m, the relevant provisions for stairs (refer to Paragraphs 3.13.4 and 3.13.5) shall apply.



**Figure 3.22** Single escape routes – split level exits  
Paragraph 3.13.6



### 3.14 Special conditions for safe paths

**SM** 3.14.1 *Safe paths* from **risk group SM** may also serve other *risk groups* where:

- a) A single *escape route* complying with Paragraph 3.13 is permitted, or
- b) Alternative *escape routes* which are *safe paths* are provided.

These requirements shall also apply to all *firecells* on lower floors using the same *escape routes*.

### 3.15 Doors subdividing escape routes

#### Door closers and latching

3.15.1 Except as permitted by Paragraph 3.15.7 (revolving doors, automatic doors and access control systems), doors on *escape routes* shall satisfy the following requirements:

- a) They shall be hinged or pivoted on one vertical edge only, except that sliding doors may be used where the space, including an *exitway*, has an *occupant load* of less than 20. Roller shutter doors or tilt doors shall not be used as *escape routes* width unless they are open at all times the space is occupied. A roller shutter door or tilt door is permitted to be the only *access route* to an intermittently *occupied space* where the roller shutter door is open at all times the space is occupied, and
- b) *Fire and smoke control doors* shall be self-closing, and the self-closing device shall either be:
  - i) active at all times, or
  - ii) activated by releasing a *hold-open device* in response to operation of a smoke detector (see Paragraph 3.15.10), or
  - iii) a self-closer that is activated by operation of a smoke detector but allows the door to swing freely at other times. The smoke detector requirements shall be the same as for a *hold-open device* (see Paragraph 3.15.10), and

- c) If such doors are required to be secure, they shall be fitted with simple fastenings that can be readily operated from the direction approached by people making an escape complying with Paragraph 3.15.14, and
- d) They shall not be fitted with any locking devices unless these comply with Paragraph 3.15.2, and
- e) They shall have door handles which satisfy the requirements of Acceptable Solution D1/AS1 for use by *people with disabilities*, and
- f) They shall be *constructed* to ensure that the forces required to open these doors do not exceed those able to be applied:
  - i) with a single hand to release the latch (where fitted), and
  - ii) using two hands to set the door in motion, and
  - iii) using a single hand to open the door to the minimum required width.

#### Locking devices

3.15.2 If the *building* is occupied, locking devices shall:

- a) Be clearly visible, located where such a device would be normally expected and, in the event of *fire*, designed to be easily operated without a key or other security device and allow the door to open in the normal manner. If the operation of a locking device is unusual, such as the pressing of a button close to the door, it shall have signage that complies with NZBC Clause F8, and
- b) Not prevent or override the direct operation of panic fastenings fitted to any door, and
- c) If they are of an electromechanical type, in the event of a power failure or door malfunction, either:
  - i) automatically switch to the unlocked fail-safe condition, or
  - ii) be readily opened by an alternative method satisfying the requirements of Paragraph 3.15.2 a), and

Amend 2  
Nov 2020

- d) If the *escape height* is greater than 25 m occupants in the vertical *safe path* shall be able to re-enter a floor at a maximum interval of 4 floors. Doors required to be unlocked from the *safe path* side may be unlocked at all times or only when the *fire alarm* is activated. Doors designated as available for entry shall have signage indicating their status.

### Direction of opening

Amend 2  
Nov 2020

**3.15.3** Doors shall be hung to open in the direction of escape if the door serves a room or area with more than 50 occupants. This includes doors:

- Located on an *open path*
- Leading into, or within an *exitway*
- At *final exits*.

Amend 2  
Nov 2020

If escape is in either direction, doors shall be capable of swinging both ways.

For manual sliding doors, see Paragraph 3.15.1.

Amend 2  
Nov 2020

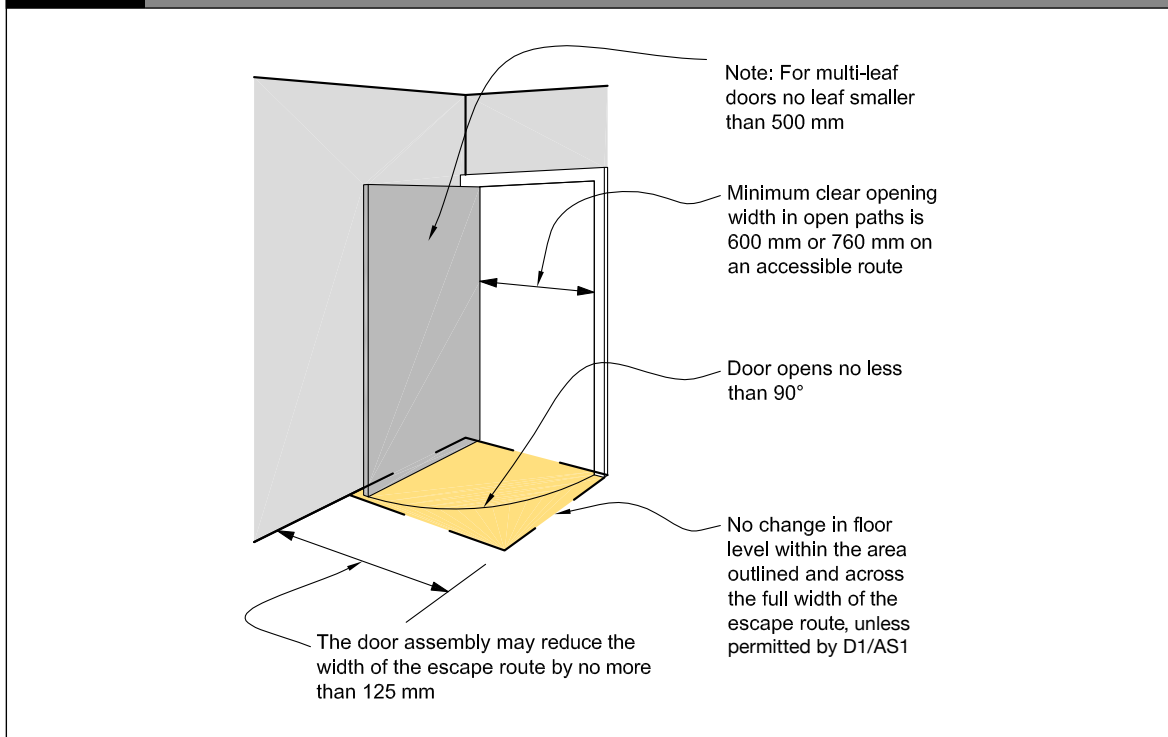
- SI 3.15.4** In *risk group SI*, manual doors (excluding bedroom doors) used for the passage of beds in care and detention activities shall be capable of swinging in both directions.

### Degree and width of opening

**3.15.5** Doors on *escape routes* (see Figure 3.23) shall satisfy the following requirements:

- In *open paths*, provide an unobstructed opening width of no less than 760 mm (Table 3.1a) or 950 mm where the movement of beds is required and, when multi-leaf, have no single leaf less than 500 mm wide. The minimum door opening width may be reduced to 600 mm if it is not required to be an *accessible route*, and
- Within *exitways* (including entry and *final exit* doors), reduce the minimum *exitway* width required by Paragraph 3.3 by no more than permitted under Table 3.1a.
- Open no less than 90°, and

**Figure 3.23** Degree and width of openings  
Paragraph 3.3.6 d) and 3.15.5



- d) Open onto a floor area which:
- i) extends for a distance of no less than the arc of the door swing, and
  - ii) is at the same level on both sides of the door for the full width of the *escape route* unless permitted by D1/AS1, and
- e) When opened, not cause the door swing to obstruct the minimum required width of any *escape route* (see Figure 3.24), and

Amend 2  
Nov 2020

- f) In the case of care patients the doors shall be of sufficient width to allow the passage of a bed and essential patient life support equipment.

### Vision panels

**3.15.6** Vision panels shall be provided on doors which:

- a) Are hung to swing both ways, or
- b) Subdivide corridors used in *escape routes*, or
- c) Lead into, or are within *exitways*, except where:
  - i) the door is the egress for a sleeping space (such as a ward bedroom or *suite*), or a sanitary facility for use by a single person, or
  - ii) the door serves an unoccupied space, such as a closet.

Amend 2  
Nov 2020

### Revolving doors, automatic doors and access control systems

**3.15.7** Revolving doors (see Figure 3.25 (a)), automatic doors (of all types) and access control systems shall:

- a) Not be allowed across an *escape route* at any point leading into or within an *exitway*, but

- b) Be allowed in an *open path* or at a *final exit*, provided that in the event of a power failure or malfunction, the doors or access control systems continue to provide a safe *means of escape from fire* without reducing the required width by automatically opening and remaining open, or being readily pushed to the outward open position by the *building* occupants in an emergency (see Figure 3.25).

**3.15.8** Paragraph 3.15.7 b) need not apply if alternative swing doors of the required width are provided immediately adjacent to the revolving or sliding doors. Refer to Paragraph 3.16 for signage requirements.

### Hold-open devices

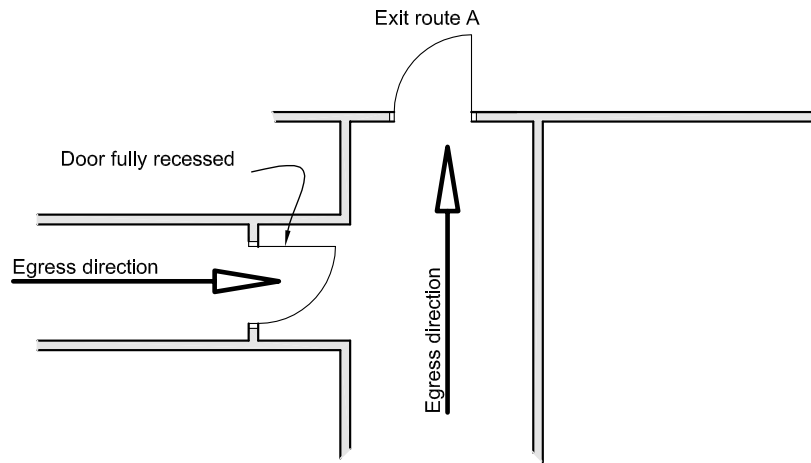
**3.15.9** Smoke detector activated *hold-open devices* shall be fitted to *fire doors* or *smoke control doors* required:

- a) Between *open paths* and *exitways* if the *occupant load of the building* is greater than 1000, and
- b) For subdividing long corridors (refer to Paragraph 4.12), and
- c) In *fire separations* where an *escape route* passes into an adjacent *firecell* (refer to Paragraph 3.7.13), and
- d) In locations where, due to the type or volume of occupant traffic using the doors, the doors may be kept open by unauthorised means, and
- e) In *early childhood centres* located on upper floors of multi-storey *buildings*.

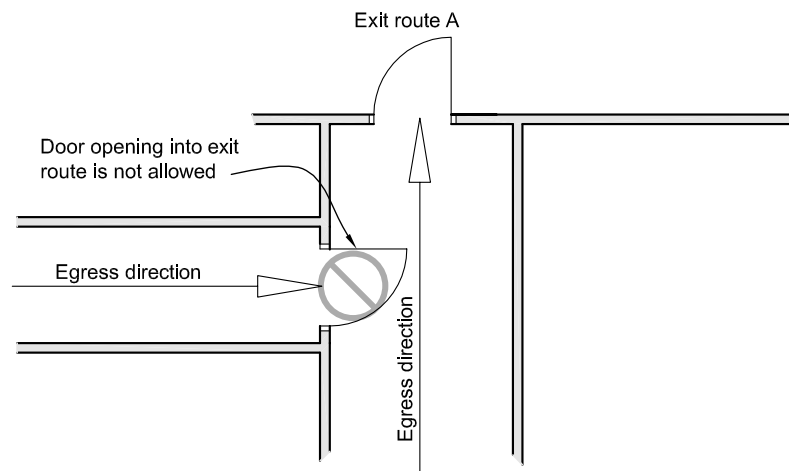
**3.15.10** Detectors for releasing *hold-open devices* shall be smoke detectors which are:

- a) Integral with the *hold-open device* and comply with Appendix C6.1.6, or
- b) Located on the ceiling adjacent to the *doorset* on both sides of the *doorset*, or
- c) Part of an automatic smoke detection system on both sides of the *doorset*.

Figure 3.24 Door opening  
Paragraph 3.15.5 e)



(a) CORRECT DOOR OPENING

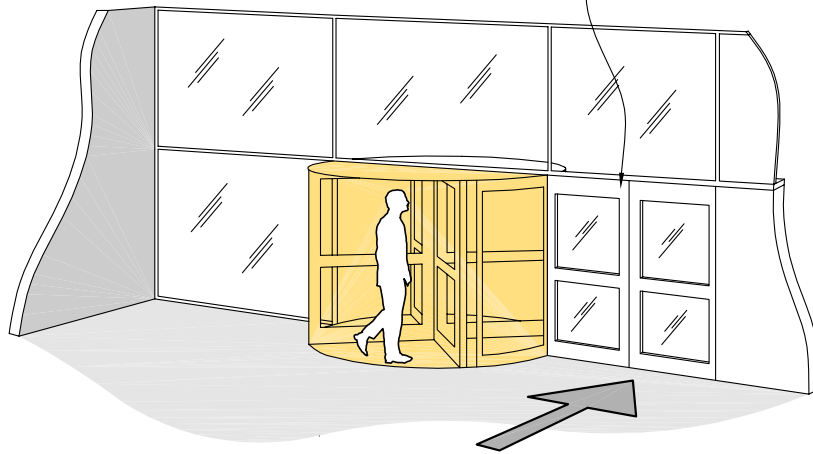


(b) INCORRECT DOOR OPENING

**Figure 3.25** Revolving and automatic sliding doors  
Paragraph 3.15.7

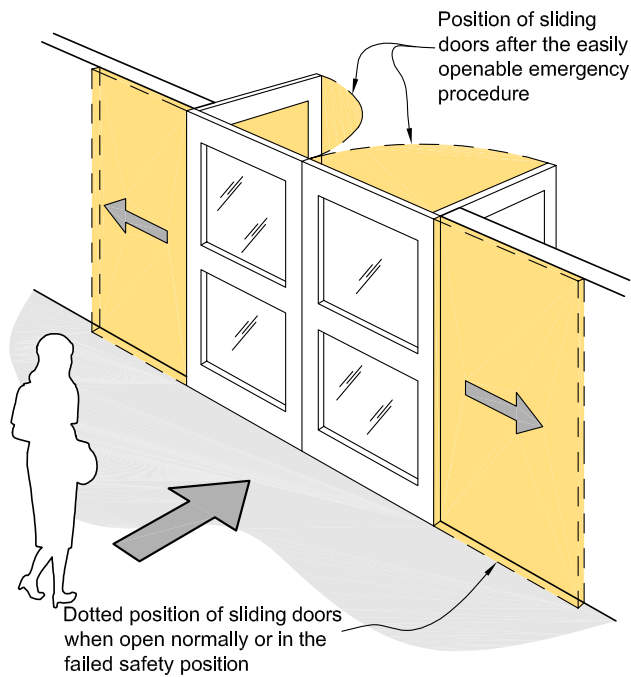
Revolving doors are permitted across an open path or final exit provided they are constructed to fail safely in an emergency.  
Revolving doors are not allowed across an escape route leading to or within an exitway

Alternatively outward opening doors shall be provided immediately adjacent to the revolving doors



Escape route

(a) REVOLVING DOORS



Position of sliding doors after the easily openable emergency procedure

Dotted position of sliding doors when open normally or in the failed safety position

(b) SLIDING DOORS

### Delayed action unlocking devices

**3.15.11** Delayed action unlocking devices on *escape routes* shall be installed only if:

- a) The *firecell* is protected by a Type 4 or Type 7 system, and
- b) *Fire* alarm activation instantly overrides any delay, and
- c) The delay in operation does not exceed 15 seconds, and
- d) Signage warning of the delay in operation and complying with F8/AS1 is provided.

### Panic fastenings

**CA** **3.15.12** In retail areas serving more than 500 occupants and in crowd activities (as described by **risk group CA**) of more than 100 people, panic fastenings shall be fitted on doors on the *escape route* including *exitways* and *final exits*.

Amend 2  
Nov 2020

**3.15.13** Panic fastenings are latching devices which shall meet the following requirements:

- a) The actuating portion shall consist of a horizontal bar or panel which shall extend across no less than half the width of the door leaf, and be located between 800 mm and 1200 mm above the floor, and
- b) When a horizontal force of that able to be applied using one hand to the bar or panel the door lock shall release allowing the door to swing open freely.

### Simple fastenings

**3.15.14** Doors on *escape routes* (whether or not the doors are *fire doors*) shall be fitted with simple fastenings that can be easily operated from the direction from which people approach when making their escape.

### 3.16 Signs

**3.16.1** All *building* features shall have signs complying with F8/AS1.

# Part 4: Control of internal fire and smoke spread

## CONTENTS

- 4.1 Firecells
- 4.2 Glazing in fire and smoke separations
- 4.3 Structural stability during fire
- 4.4 Fire stopping
- 4.5 Firecell construction
- 4.6 Specific requirements for sleeping areas
- 4.7 Specific requirements for exhibition and retail areas in risk group CA
- 4.8 Tiered seating in risk group CA
- 4.9 Exitways
- 4.10 Intermittent activities
- 4.11 Protected shafts
- 4.12 Long corridor subdivision
- 4.13 Floors
- 4.14 Subfloor spaces
- 4.15 Concealed spaces
- 4.16 Closures in fire and smoke separations
- 4.17 Interior surface finishes, floor coverings and suspended flexible fabrics
- 4.18 Building services plant

## 4.1 Firecells

4.1.1 Adjoining *firecells* are required to be *fire separated* from each other by the highest:

- a) *Life rating* specified in Paragraph 2.3 if both *firecells* are under common ownership, or
- b) *Property rating* specified in Paragraph 2.3 if both *firecells* are under different ownership, or a property boundary exists between the two *firecells*, or where explicitly stated in this Acceptable Solution.

*Firecells* shall be *fire separated* from each other by the higher of the two *FRRs* if the adjoining *firecell* has a higher *FRR* (refer to Paragraph 2.3).

## Firecells in vehicle parking

**VP** 4.1.2 *Risk group VP firecells* shall be separate *firecells* within the *building* and:

- a) *Firecells* shall be *fire separated* from other *firecells* by either:
  - i) the *fire resistance rating* specified in Table 2.4 if the *firecell* is categorised in **risk group VP**, or
  - ii) the higher of the two *fire resistance ratings* specified in Table 2.4 if it is categorised in any other *risk group*, and
- b) Within the **risk group VP** *firecell*, all floors (including *intermediate floors*) and their supporting structures shall achieve a *fire resistance rating* of at least the *life rating*. The *property rating* shall be used where necessary to achieve protection from spread of *fire* to neighbouring property (see Figure 4.1), and

Amend 2  
Nov 2020

Amend 2  
Nov 2020



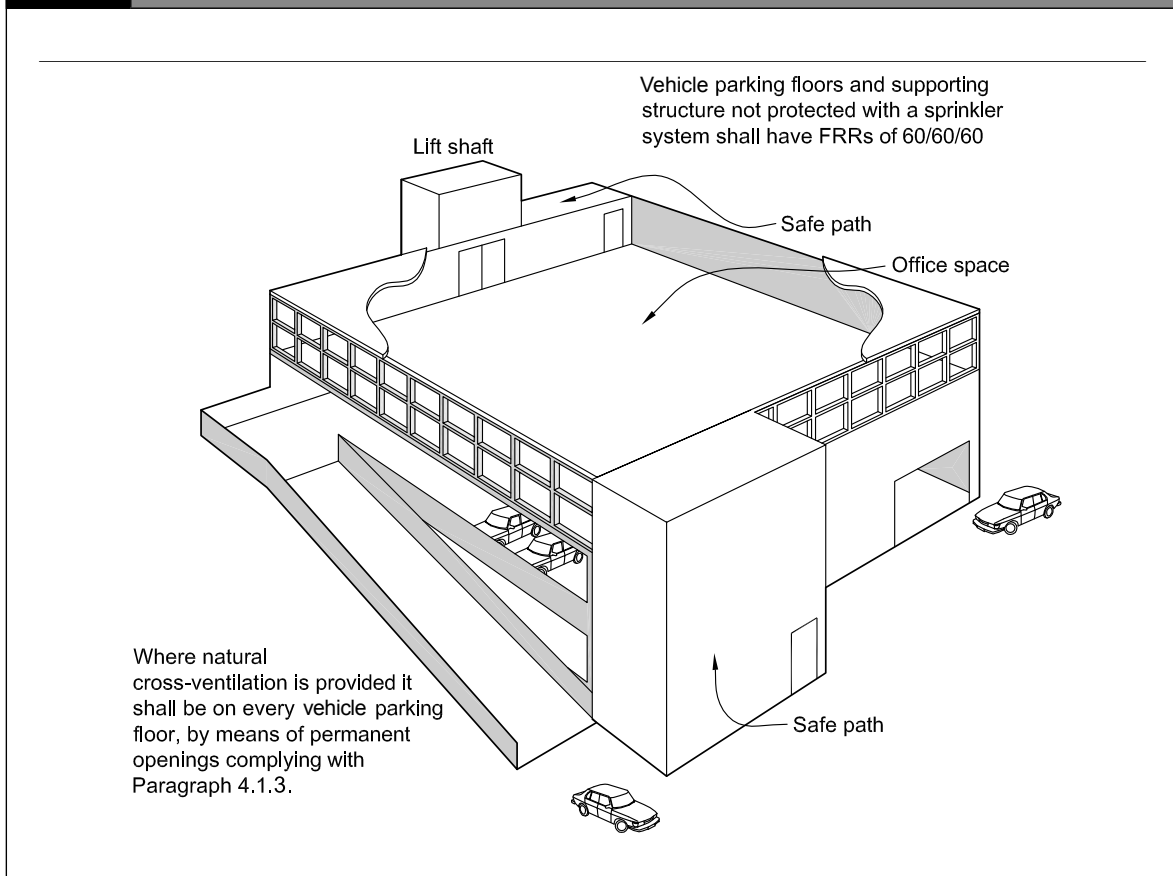
- Amend 2  
Nov 2020 | c) Within the **risk group VP firecell**, where the parking spaces and other areas of that *firecell* are unit titled, it is permitted to have the parking spaces (and an associated storage area limited to plan area of 3.0 m<sup>2</sup> and maximum height 3.0 m) unseparated from adjacent titles, and
- Amend 2  
Nov 2020 | d) Within the **risk group VP firecell**, other spaces (such as a ticket office, a gate booth or a storeroom not greater than 10 m<sup>2</sup>) are permitted when they are necessary for the operation of the **risk group VP firecell**, and
- Amend 2  
Nov 2020 | e) Service vehicle and unloading areas may be part of other support activity *firecells*.

### Natural cross ventilation in vehicle parking

- VP** 4.1.3 In **risk group VP** where a *firecell* is unsprinklered and there is parking for more than 10 vehicles, each of those *firecells* within that *building* must have natural cross ventilation (see Figure 4.1). This shall be achieved by providing perimeter walls on each floor with permanent openings to the outside environment. The size of those openings shall either be:
- no less than 50% of the wall area in each of any two opposing walls, or
  - no less than 50% of the total perimeter wall area, with those openings distributed uniformly along at least half the total perimeter wall length.

4.1.4 Where natural cross ventilation or sprinklers are provided the limitations of Paragraph 4.13.4 to 4.13.6 on *intermediate floor* area do not apply.

**Figure 4.1** Vehicle parking  
Paragraphs 4.1.2 and 4.1.3



## 4.2 Glazing in fire and smoke separations

**4.2.1** Glazing in *fire separations* shall be fixed *fire resisting glazing* having the same *FRR* values for *integrity* and *insulation* as the *fire separation*, except where uninsulated glazing is permitted within vision panels or for sprinklered *buildings* (refer to Paragraph 2.3.13).

**4.2.2** Uninsulated *fire resisting glazing* having the same *integrity* value as the *fire separation* is permitted in all sprinklered *buildings*.

**4.2.3** There is no restriction on the area of glazing in *smoke separations* (including *smoke lobbies*). Non-*fire resisting glazing* may be used if it is toughened or laminated *safety glass*. Glazing shall have at least the same smoke-stopping ability as the *smoke separation*.

### Fire doors and smoke control doors

**4.2.4** Glazing in *fire doors* shall be *fire resisting glazing* having the same *integrity* value as the door. If the door requires an *insulation* value, an uninsulated vision panel may be used without downgrading the *insulation* value of the door. Vision panels shall comply with NZS 4520.

**4.2.5** Glazing in *smoke control doors* shall meet the requirements for *smoke separations*.

## 4.3 Structural stability during fire

### Stability of building elements having an FRR

**4.3.1** To avoid premature failure the structural *stability* of primary *building elements* with an *FRR* is to be retained for the duration of that *FRR*.

*Primary elements* located entirely within a *firecell* and providing support to *fire separations* may need to be evaluated for *fire* exposure from multiple sides simultaneously.

**4.3.2** During a *fire*, *primary elements* shall resist collapse under:

- a) The design dead and live loads required by NZBC Clause B1, and
- b) Any additional loads caused by the *fire*.

Amend 2  
Nov 2020

### Unrated primary elements permitted

**4.3.3** In many cases *primary elements* are rated for *structural adequacy*, and sometimes for *integrity* and *insulation*. However, *primary elements* need not have an *FRR* where any of the following circumstances exist:

- a) They are located outside an *external wall* which is 2.0 m or more from the *relevant boundary*, and are shielded from the effects of *fire* by protected areas of the wall (see Figure 4.2), or
- b) They are added to strengthen an existing *building* and are required only to carry horizontal loads induced by wind or earthquake.

### Providing vertical stability

**4.3.4** *Building elements* required to have an *FRR* shall have their vertical *stability* provided in one or more of the following ways:

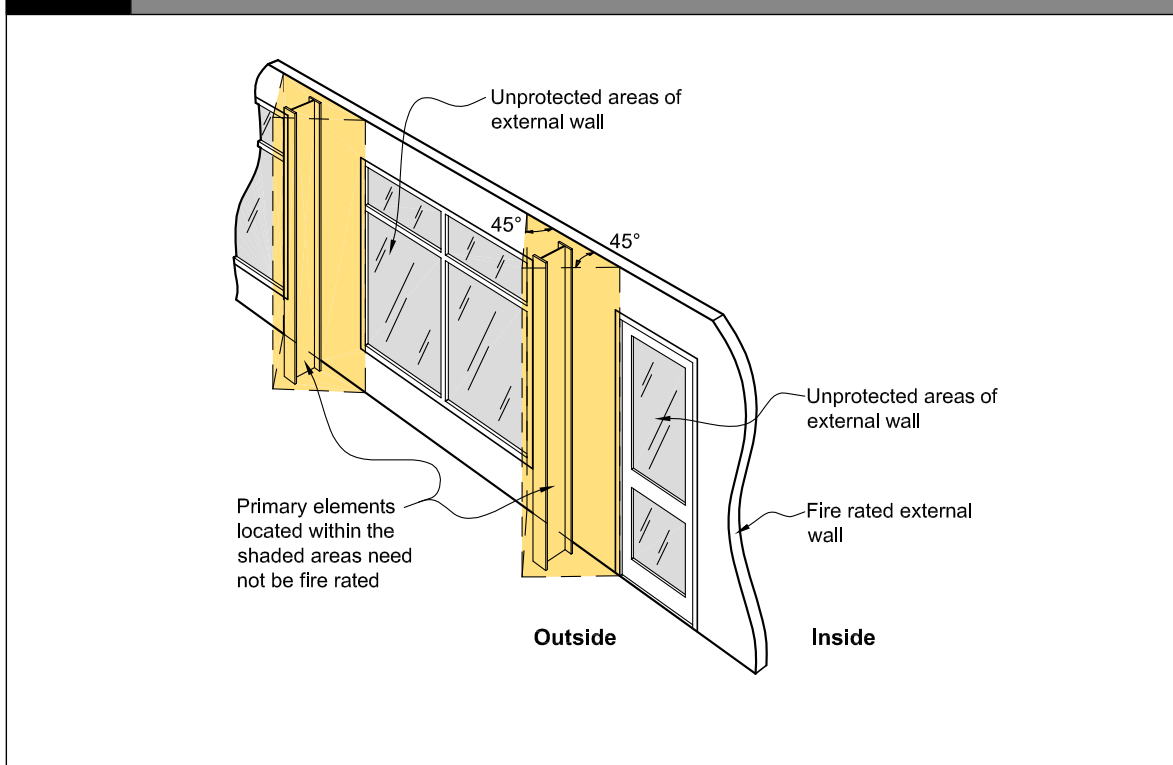
- a) *Primary elements* in a vertical orientation (e.g. walls and columns) shall be rated for *structural adequacy*, and/or
- b) *Primary elements* in a horizontal orientation (e.g. floors and beams) shall be supported by *primary elements* with at least an equivalent *structural adequacy* rating.

### Providing horizontal stability

4.3.5 *Building elements* required to have an *FRR* shall have their horizontal *stability* provided in one or more of the following ways:

- a) Be cantilevered from a structural base having an *FRR* of no less than that of the *building element* concerned, and/or
- b) Be supported within the *firecell* by other *building elements* having an *FRR* of no less than that required for the element being supported. The *structural adequacy* and diaphragm action of supporting *building elements*, located entirely within a single *firecell*, must be assessed when exposed to *fire* from all relevant sides simultaneously, and/or
- c) Be supported by *primary elements* outside the *firecell*.

**Figure 4.2** Permissible positioning of unrated primary elements  
Paragraph 4.3.3



## 4.4 Fire stopping

### Introduction

**4.4.1** The continuity and effectiveness of *fire separations* shall be maintained around *penetrations*, and in gaps between or within *building elements*, by the use of *fire stops*.

### Fire stops

**4.4.2** *Fire stops* shall have an *FRR* of no less than that required for the *fire separation* within which they are installed, and shall be tested in accordance with Appendix C C5.1.

**4.4.3** *Fire stops* and methods of installation shall be identical to those of the prototype used in tests to establish their *FRR*.

**4.4.4** The material selected for use as *fire stops* shall have been tested for the type and size of the gap or *penetration*, and for the type of material and *construction* used in the *fire separation*.

**4.4.5** A *fire stop* for a *penetration* is not required to have an *insulation* rating if means are provided to keep *combustible* materials at a distance of 300 mm away from the *penetration* and the *fire stop* to prevent ignition.

## 4.5 Firecell construction

**4.5.1** Each of the *building elements* enclosing a *firecell* is permitted to have a different *FRR*, as this rating will depend on the characteristics of the *firecell*, the reason for the *FRR*, and the *risk groups* contained on either side of any *fire separation*.

**4.5.2** Except where *intermediate floors* are permitted, each floor in a multi-storey *building* shall be a *fire separation*.

**4.5.3** *Fire separations* and *smoke separations* shall have no openings other than:

- a) For closures such as *fire doors*, *smoke control doors*, *fire* or *smoke curtains*, *fire shutters*, *fire dampers* and *smoke dampers*, and
- b) *Penetrations* complying with Paragraph 4.4, and
- c) For glazing permitted by Paragraph 4.2.

**4.5.4** *Firecell* and *smokecell* effectiveness shall be maintained by ensuring continuity of *fire separations* and *smoke separations* at separation junctions, and around joints where closures, *protected shafts* and *penetrations* occur.

### Junctions of fire separations

**4.5.5** Where *fire separations* meet other *fire separations* or *external walls*, they shall either be bonded together or have the junction *fire stopped* over its full length (see Figures 4.3, 4.4 and 4.12).

**4.5.6** Where one *fire separation* is a wall and the other a floor, the wall/floor junction shall be *constructed* with the *FRR* required for the higher rated element.

### Junctions with roof

**4.5.7** Vertical *fire separations* and *external walls* shall either:

- a) Terminate as close as possible to the external roof cladding and *primary elements* providing roof support, with any gaps fully *fire stopped* (see Figures 4.3 and 4.4), or
- b) Extend not less than 450 mm above the roof to form a parapet.

### Ceiling space firecells

**4.5.8** Large roof or ceiling spaces may be *constructed* as separate *firecells* above more than one occupied *firecell* provided that the ceiling is a *fire separation* rated from below. In this situation, vertical *fire separations* in the *firecell* below need terminate only at the ceiling.

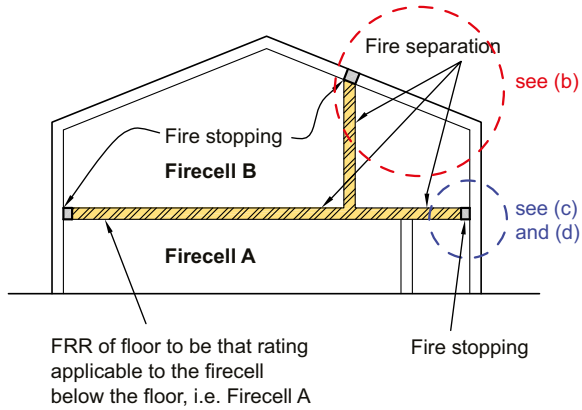
### Sealing of gaps

**4.5.9** To avoid the passage of smoke through *fire separations* and *smoke separations*, gaps shall be sealed with *fire* resistant materials complying with AS 1530.4 in their intended application if they are located:

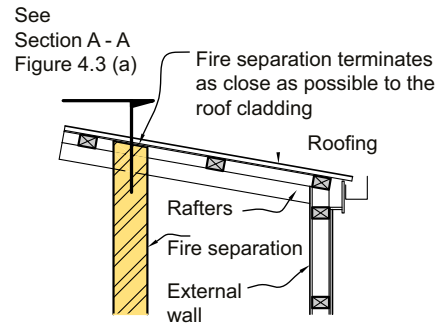
- a) In *smoke separations*, and between *fire separations* and *smoke separations*, or
- b) Around glazing in *smoke separations*, or
- c) Between *fire separations* and unrated parts of *external walls*, or
- d) Between *smoke separations* and unrated parts of *external walls*.

**4.5.10** Gaps around *penetrations* shall be *fire stopped* (see Paragraph 4.4).

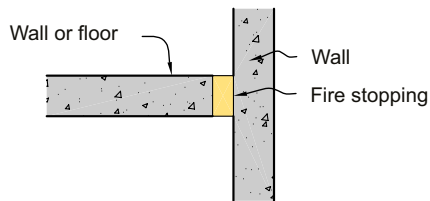
**Figure 4.3** Junction of fire separations – 1  
Paragraphs 4.5.5, 4.5.7 and 4.15.3



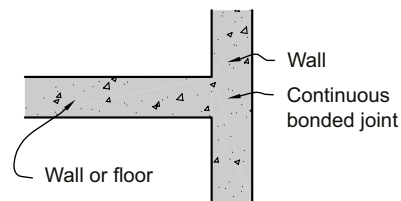
(a) SECTION



(b) SECTION  
JUNCTION FIRE SEPARATION  
WALL TO ROOFING

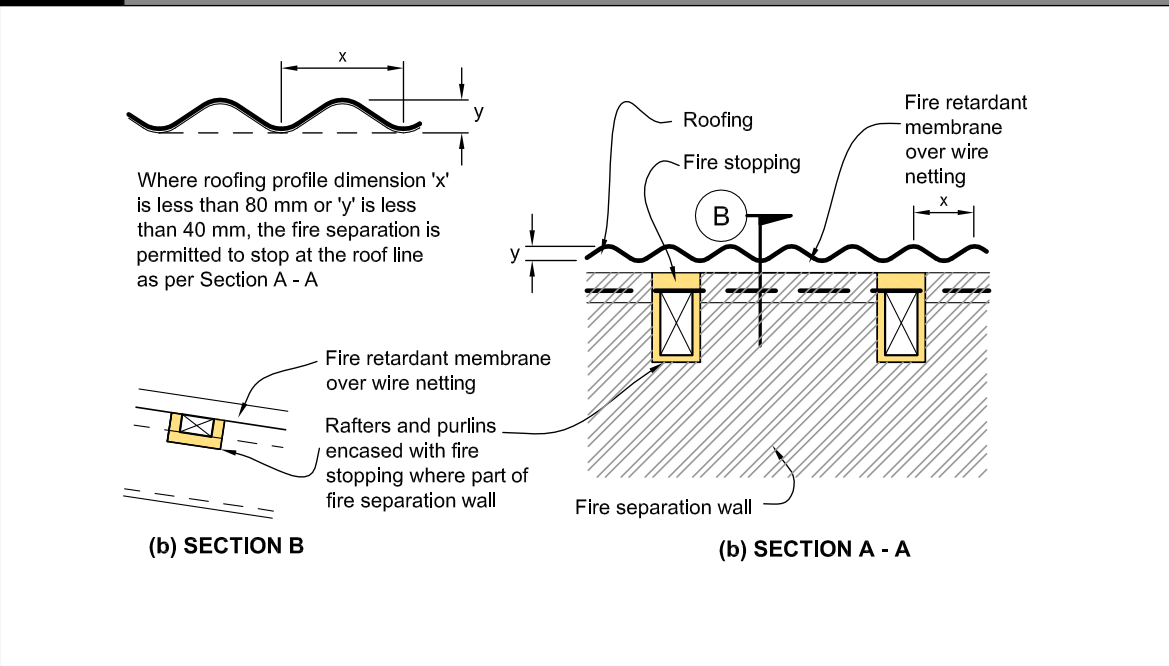


(c) PLAN OR SECTION  
JUNCTION FIRE SEPARATION  
WALL AND FLOOR



(d) PLAN OR SECTION  
JUNCTION FIRE SEPARATION  
WALL AND FLOOR

**Figure 4.4** Junction of fire separations – 2  
Paragraphs 4.5.5, 4.5.7 and 4.15.3



## 4.6 Specific requirements for sleeping areas

### Group sleeping areas

Amend 2  
Nov 2020

SI SM

**4.6.1** Group sleeping areas in **risk groups SM** or **SI** shall be *fire separated* from each other and from other sleeping and non-sleeping areas with a *FRR* in accordance with Paragraph 2.3.

SM

**4.6.2** In **risk group SM**, a *group sleeping area* shall contain no more than:

- 40 beds if unsprinklered, or
- 160 beds if sprinklered.

Amend 2  
Nov 2020

SM

**4.6.3** In **risk group SM**, a *group sleeping area* may contain non-fire rated partitions if:

- The *group sleeping area* contains no more than 40 beds, whether or not sprinklers are installed, and
- The partitions do not fully enclose any *occupied space* in the *group sleeping area*, and have at least one side open, and
- All *occupied spaces* within the *group sleeping area* are available to all occupants at any time, and
- The openings between the partitions as well as any other part of the *open path* must be unobstructed, and
- WCs, urinals, baths, showers or bidets may be fully enclosed.

See Figure 4.5(a)

SI

**4.6.4** For **risk group SI**, if there is only one *group sleeping area*, or the *group sleeping areas* are not adjacent to one another, the *group sleeping area* shall contain no more than 12 beds.

Amend 2  
Nov 2020

Where there are two or more *group sleeping areas* and these are adjacent to one another, each *group sleeping area* shall contain no more than 20 beds and have sufficient space to accommodate, in an emergency, the beds from an adjacent *group sleeping area*.

**SI** 4.6.5 In **risk group SI**, a *group sleeping area* may be subdivided with full height *smoke separations* including *smoke control doors* which need not be fitted with self-closers. See Figure 4.5(b)

**SI** 4.6.6 In **risk group SI**, a *group sleeping area* may be subdivided with non-fire rated partitions if it contains no more than 6 beds. See Figure 4.5(c)

Amend 2  
Nov 2020

### Direct support functions

**SM SI** 4.6.7 *Direct support functions* may be included in a *group sleeping area* without *fire or smoke separations*. *Direct support functions* may include sanitary facilities and tea making activities for use by the occupants, but may not include cooking facilities.

### Communal service functions for group sleeping areas

**SM SI** 4.6.8 *Communal service functions* shall be separated from *group sleeping areas* or *suites* with *fire separations* having an *FRR* in accordance with Paragraph 2.3.

### Suites

**SM** 4.6.9 A *suite* shall be a separate *firecell* with *fire separations* with an *FRR* in accordance with Paragraph 2.3.

A *group sleeping area* may be subdivided to form *suites*.

4.6.10 A *suite* shall contain no more than 12 beds.

4.6.11 A *suite* may be subdivided with non-fire rated construction to provide separate spaces for sleeping, cooking, or sanitary facilities.

Amend 2  
Nov 2020

### Household units

**SM** 4.6.12 A *household unit* shall be a single *firecell* separated from every other *firecell* by *fire separations* having an *FRR* in accordance with Paragraph 2.3.

4.6.13 A *household unit* may contain one or more floors provided that the *open path* length provisions of Table 3.2 are satisfied.

### Vehicles

**SM SI** 4.6.14 Service vehicle and unloading areas within a *building* with **risk group SM** or **SI** shall be a separate *firecell* complying with the requirements of **risk group VP**.

**SM** 4.6.15 Where a vehicle parking garage associated with **risk group SM** is provided solely for the use of the occupants of an individual *household unit*, the garage may be included within the *household unit firecell*.

Where parking is provided for vehicles of occupants of more than one *household unit*, the parking area shall be a separate *firecell* complying with the requirements of **risk group VP**.

Amend 2  
Nov 2020

### Special care facilities

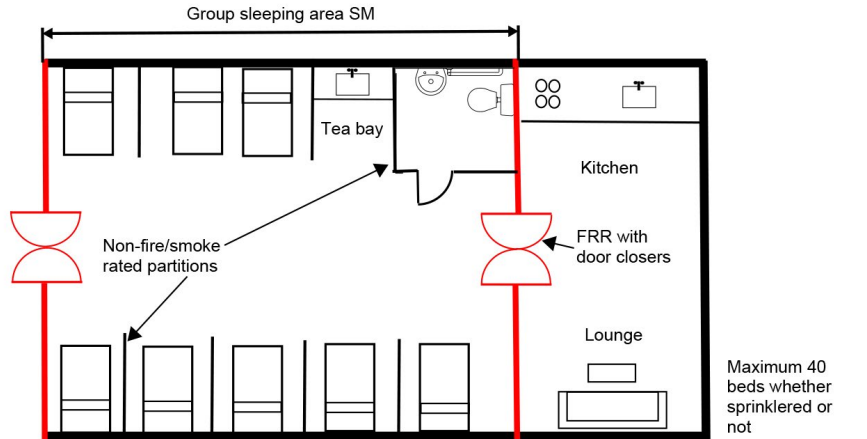
**SI** 4.6.16 Spaces where procedures using sedation (including dentistry and dialysis) are carried out require longer evacuation times. Such spaces shall be either:

- a) Contained in separate *firecells* having *fire separations* with an *FRR* of no less than 60 minutes, or
- b) Grouped together within a *firecell* which is separated from other activities by *fire separations* with an *FRR* of no less than 60 minutes. Within that *firecell*, each space shall be separated from adjacent spaces by *smoke separations*.

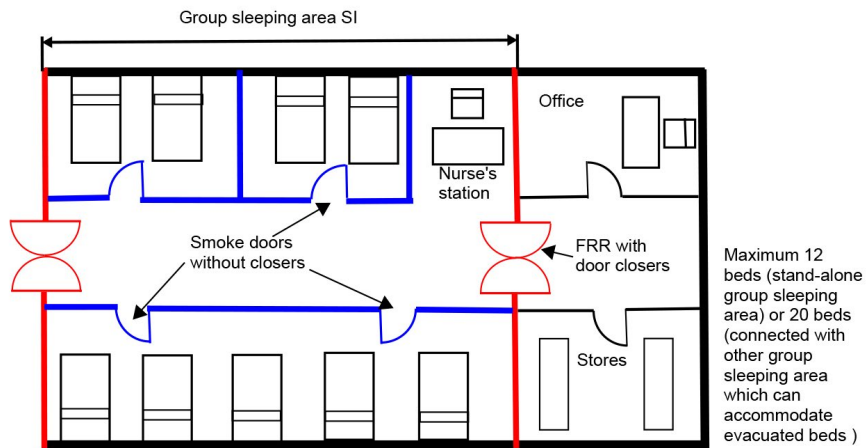
Amend 2  
Nov 2020



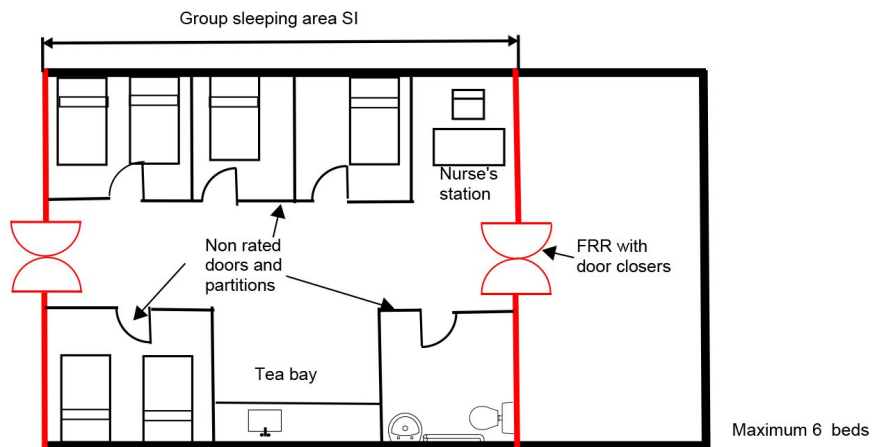
**Figure 4.5** Group sleeping areas  
Paragraph 4.6



(a) Group sleeping area SM



(b) Group sleeping area SI



(c) Group sleeping area SI

- Life rating FRR
- Smoke separations

Amend 2  
Nov 2020

## 4.7 Specific requirements for theatres, exhibition areas and retail spaces

### Theatres

**CA 4.7.1** In every unsprinklered *theatre* where the *occupant load* in the auditorium is greater than 500, the stage area (including workshops, storerooms, scenery docks, property, wardrobe or painting rooms used in connection with the *theatre*), shall be separated from the auditorium by a proscenium wall meeting the requirements of a *fire separation* having an *FRR* of no less than 30/30/30. Where the stage and supporting areas are sprinklered, the proscenium wall and curtain may be a *smoke separation*.

### Closures in theatre proscenium walls

**CA 4.7.2** The opening in the proscenium wall shall be provided with a smoke curtain, *fire curtain* or *fire shutter* (as required by Paragraph 4.7.1), that when released, shall lower under gravity in a fail safe manner. An emergency release device shall be located in the stage area on both sides of the opening.

**CA 4.7.3** If a sprinkler system is not installed, uninsulated glazing is not permitted in *fire* rated proscenium walls.

### Theatre stages

**CA 4.7.4** *Theatres* with an *occupant load* of greater than 1000 shall satisfy the following requirements:

a) The stage area shall have roof vents of no less than 5% of the stage floor area, located at the highest point above centre stage. These vents shall have a positive device to keep them closed, and may be of the counterbalanced shutter type, inclined falling type, centre pivot sash type or counterbalanced skylight type, and they shall be held normally in a closed position by a heat sensing device installed below the vent opening and its controls, but above the discharge of any sprinkler head in the vicinity, and

b) Vents shall be capable of being operated by a manual control located near the stage safety curtain release, and

c) The heat sensing device required by a) above shall be interlocked with any heating or ventilating system, so that when activated, it closes all *fire dampers* in all ducts passing through the proscenium wall.

### Exhibition and retail areas

**CA WS WB 4.7.5** If the *occupant load* for a sales, exhibition or trade fair space is greater than 500, then any adjacent storage areas in which goods are received, unpacked, stored or packed for dispatch, any areas used for workshops, and any areas used for the storage of display material or similar items, shall be *smokecells* separated from the display and sales areas.

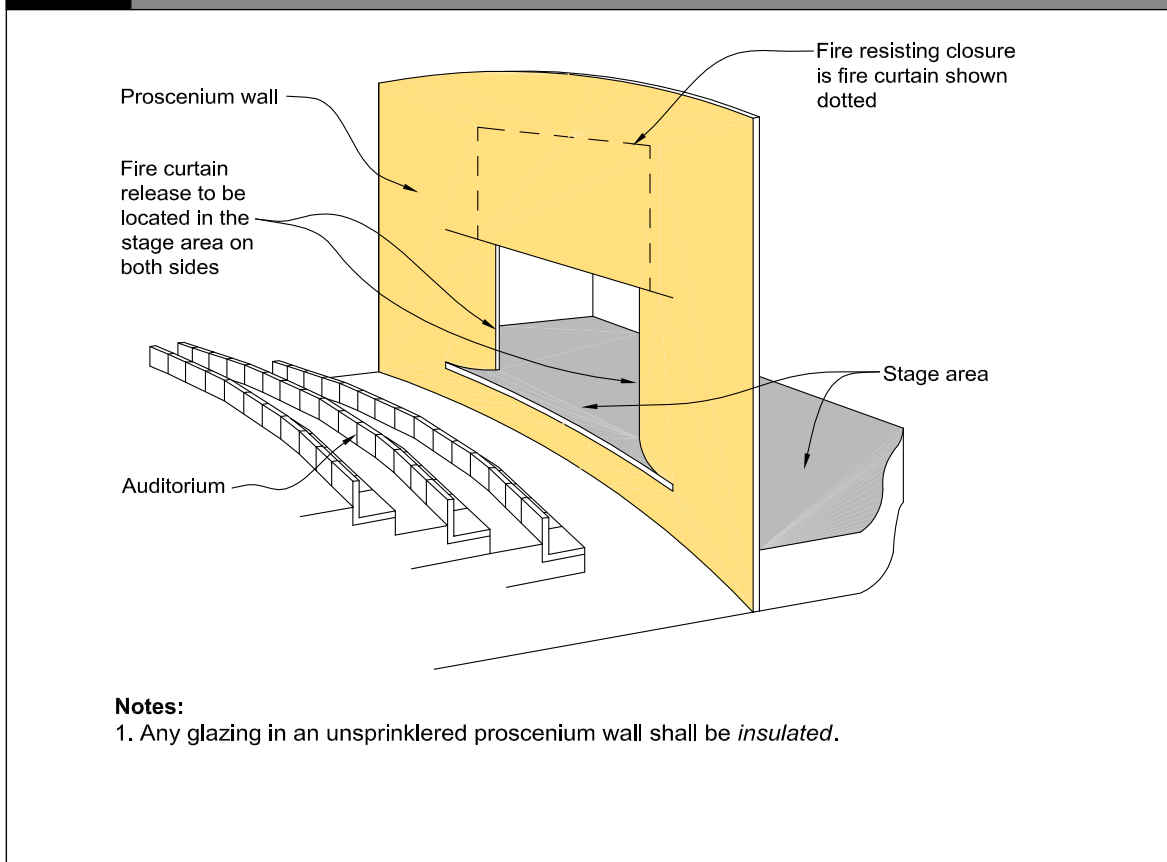
## 4.8 Tiered seating in risk group CA

**CA 4.8.1** If any enclosed, useable space beneath permanent, tiered seating is not sprinklered it shall be a *firecell* with an *FRR* in accordance with Paragraph 2.3.

**CA 4.8.2** If any enclosed, usable space beneath permanent tiered seating is sprinklered, it will not need to be a separate *firecell*. However, the supporting structure for the permanent tiered seating shall have an *FRR* in accordance with Paragraph 2.3.

**CA 4.8.3** Temporary and retractable tiered seating shall not require an *FRR*, provided the space beneath the seating is not used for storage.

**Figure 4.6** Theatre proscenium walls  
Paragraph 4.7.2



## 4.9 Exitways

**4.9.1** *Exitways*, unless external and separated by distance, shall comprise of *smoke lobbies* sized in accordance with Paragraph 3.9.2 and/or *safe paths* which are *firecells*.

**4.9.2** *Safe paths* shall be separated from all adjoining *firecells* by *fire separations* with an *FRR* in accordance with Paragraph 2.3 throughout its length.

CA WB  
WS VP  
For non-sleeping **risk groups CA, WB, WS** and **VP** with *escape heights* exceeding 10 m the *exitways* shall have *fire separations* with an *FRR* meeting the *property rating*.

**4.9.3** *Safe paths* which are stairs leading from lower floors or *basements*, and which continue to floors above the level of the *final exit*, shall have the lower levels *fire separated* from the *final exit* level. The *fire separation* shall have an *FRR* in accordance with Paragraph 2.3 or that required for the lower level, whichever is the greater.

**4.9.4** *Safe paths* which are long corridors shall be subdivided by *smoke separations* in accordance with Paragraph 4.12.

**4.9.5** Air ducts passing through *exitways* shall not include *combustible* materials.

### Vertical safe path smoke separation

**4.9.6** *Vertical safe paths* which exceed a height of 25 m shall be divided by *smoke separations* and *smoke control doors* at the landing nearest mid-height. This requirement does not apply if the *building* is sprinklered.

## 4.10 Intermittent activities

### Support activities

**4.10.1** Intermittent activities providing direct support to a primary activity of another *risk group* may be included with the other *risk group* and do not require *fire* or *smoke separation*, unless these activities are provided for enclosed waste storage or vehicle parking. The *fire safety systems* required for each *risk group* shall also apply throughout these spaces. If these spaces are required to be separate *firecells*, they shall have *fire separations* with *FRRs* in accordance with Paragraph 2.3.

**SI** For intermittent activities that provide *direct support functions* within *risk group SI* refer to Paragraph 4.6.3.

### Solid waste storage

**4.10.2** Solid waste storage areas shall be enclosed when located adjacent to *occupied spaces*; except within *risk group VP* where these areas may be unenclosed.

Enclosed solid waste storage areas within any *firecell* shall themselves be a separate *firecell* separated from adjacent *firecells* by *fire separations* having an *FRR* of no less than either the *life rating* or, if located on a *relevant boundary*, the *property rating*.

(Refer to Paragraphs 4.11.5 and 4.11.6 for waste chutes.)

### Plant, boiler and incinerator rooms

**4.10.3** Any space within a *building* (see Figure 4.7) containing an incinerator plant, boiler or machinery which uses solid fuel, gas or petroleum products as the energy source (but excluding space and local water heating appliances) shall be a separate *firecell*. The *firecell* shall be *fire separated* with an *FRR* of no less than 45 minutes where the *building* is sprinklered or no less than 90 minutes for all other cases.

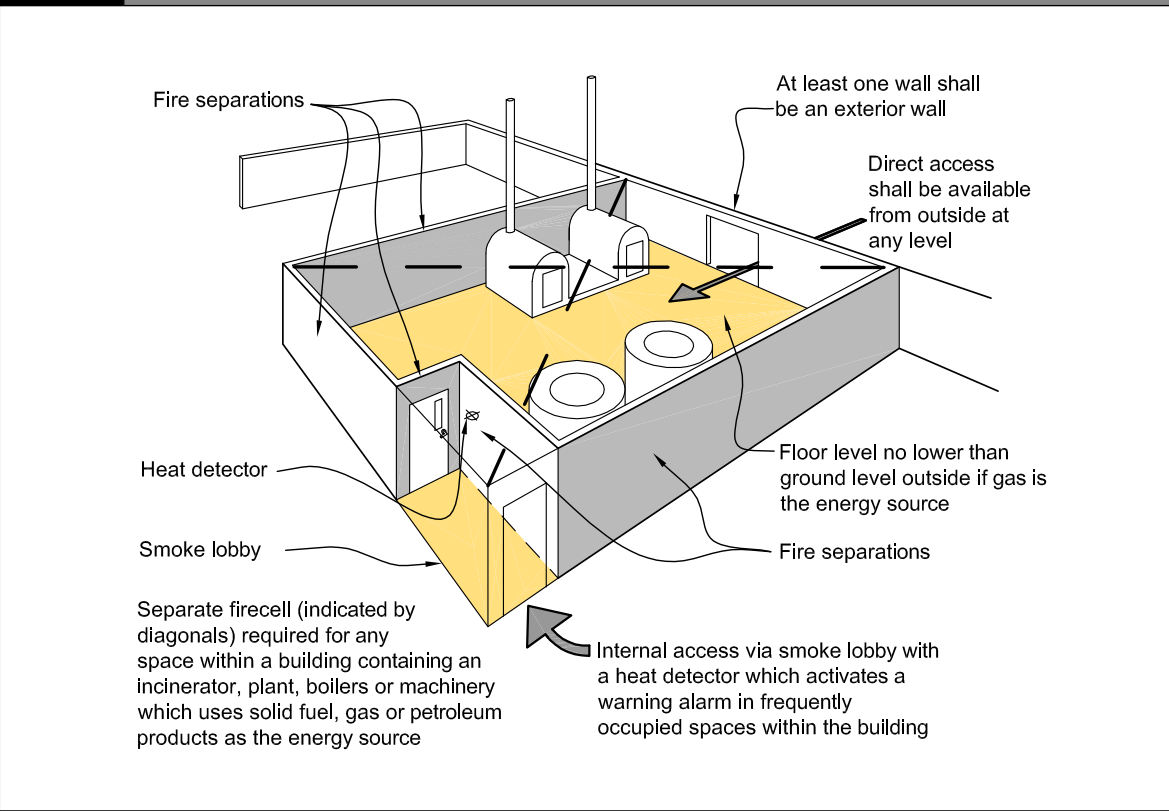
Plant, boiler and incinerator rooms in all *risk groups* shall have:

- a) At least one *external wall*, and
- b) Either external access that may be at any floor level including the roof or alternative internal access that shall be via a *smoke lobby* that is protected with a heat detector connected to a *fire alarm system*, and
- c) Floor levels no lower than the ground level outside the *external walls* if gas is the energy source.

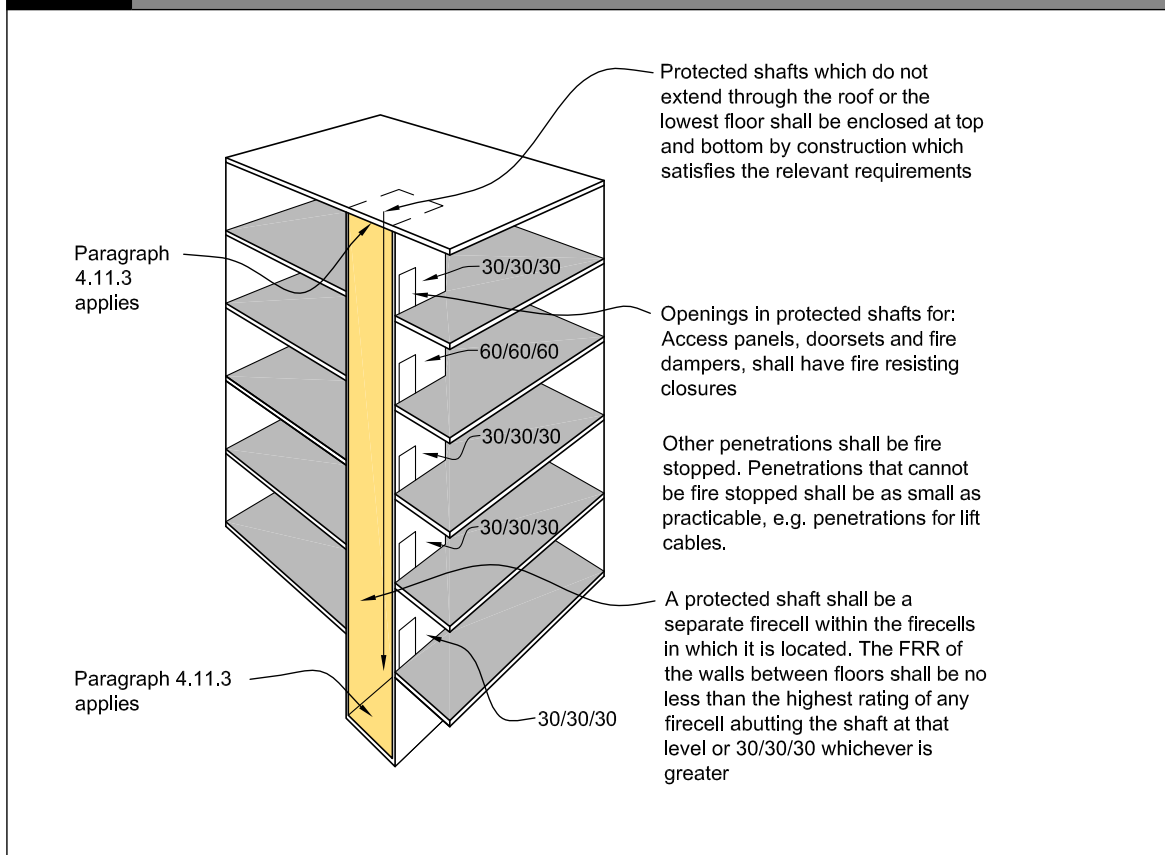
**4.10.4** If a building services plant is contained in a *building* which is solely for the purposes of containing such plant, and that *building* is separated by 3.0 m or more from any *adjacent building*, only Paragraph 4.10.3 c) shall apply.

Amend 2  
Nov 2020

**Figure 4.7** Plant, boiler and incinerator rooms  
Paragraph 4.10.3



**Figure 4.8** Protected shafts  
Paragraph 4.11.2, 4.11.3, 4.13.1 and 4.13.2



## 4.11 Protected shafts

**4.11.1** Every *protected shaft* shall be a separate *firecell* within the *firecell* or *firecells* in which it is located (see Figure 4.8). The shaft walls between each floor shall have an *FRR* of no less than that required for that level. The *FRR* of the shaft wall shall apply to both sides equally, except in the case of lift landing doors (refer to Paragraph 4.16.11).

### Lifts, conveyors and services

**4.11.2** Lifts, conveyors and services which pass from one *firecell* to another shall be enclosed within *protected shafts*.

### Fire separation

**4.11.3** *Protected shafts* which do not extend through the roof or lowest floor shall be enclosed at their top and bottom by *construction* which satisfies the relevant requirements of Paragraph 4.4 for *fire stopping* (see Figure 4.8).

### Openings in protected shafts

**4.11.4** There shall be no openings in *protected shafts* except for:

- Access panels having an *FRR* of no less than that required for the shaft, or
- Doorsets* providing access to lifts and complying with smoke control requirements, or
- Openings for lift ropes passing into a lift motor room, which shall be as small as practicable, or

- d) *Fire dampers* serving a ventilation duct and complying with requirements for *fire resisting closures*, or
- e) *Penetrations* which satisfy Paragraph 4.4 for *fire stopping*, or
- f) Fittings with an *FRR* of no less than that required for the shaft.

**Solid waste and linen chutes**

**4.11.5** Solid waste and linen chutes which pass from one *firecell* to another shall be *protected shafts* or contained within a *protected shaft*.

In unsprinklered *buildings* each chute shall be equipped with automatic sprinkler heads connected to any water supply pipe capable of meeting the minimum design criteria for the selected sprinkler head. These sprinklers shall be installed at the top of each chute and in the space into which the chute discharges. The minimum residual pressure in the water supply pipe shall be 50 kPa with two sprinkler heads operating.

**4.11.6** Solid waste and linen chutes shall have no inlet or discharge openings within an *exitway*.

**4.12 Long corridor subdivision**

**4.12.1** Long corridors shall be subdivided by *smoke separations* and *smoke control doors* (see Figure 4.9) which shall be evenly spaced along these corridors and no further apart than the distance specified in Table 4.1 for each *risk group*.

**4.13 Floors**

**4.13.1** Floors in *buildings* shall be *fire separations* (see Figure 4.8) except if any of the following conditions are satisfied:

- a) Where the floor is an *intermediate floor* within a *firecell* (refer to Paragraphs 4.13.3 and 4.13.8 for *FRR* requirement), or
- b) The floor is the lowest floor above an unoccupied subfloor space, and complies with Paragraph 4.14.1.

**4.13.2** Floors only need to be rated from the underside. The *FRR* of a floor shall be that rating applicable to the *firecell* directly below the floor.

Table 4.1 Long corridor subdivision (metres) Paragraph 4.12.1		
Risk group	Safe path	Open path
SM	80 <sup>1</sup>	40 <sup>1</sup>
SI	120	60
CA	80 <sup>1</sup>	40 <sup>1</sup>
WB	80 <sup>1</sup>	40 <sup>1</sup>
WS	120	60
VP	80 <sup>1</sup>	40 <sup>1</sup>

**Note:**  
1) These lengths may be increased by 50% if the *building* is sprinklered.

## Intermediate floors

**4.13.3** *Intermediate floors*, including their supporting *primary elements* and stairs, shall have *FRRs* of at least 30 minutes.

**4.13.4** The maximum combined area of *intermediate floors* within a *firecell* shall be the lowest of:

- a) 20% of the area of the *firecell* floor not including the area of the *intermediate floors* if the *intermediate floors* are enclosed or partitioned, or 40% of the area of the *firecell* floor, not including the area of the *intermediate floors* if the *intermediate floors*:
  - i) are completely open, or
  - ii) the *building* has a Type 4 or 7 system, or
- b) A total floor area that accommodates no more than 100 occupants based upon the *occupant load* of the space (refer to Paragraph 1.4).

**SI SM** **4.13.5** *Firecells* containing *direct support functions* to a sleeping *firecell* shall have only one *intermediate floor*.

**4.13.6** Where there are two or more *intermediate floors*, the height difference between *intermediate floors* shall not exceed 1.0 m.

**WS WB** **4.13.7** In warehouse *firecells* that contain storage at a height of more than 3.0 m, *intermediate floors* shall be limited to a total area of 35 m<sup>2</sup>.

**SM** **4.13.8** The requirements for *intermediate floors* within Paragraphs 4.13.3 to 4.13.7 do not apply within *household units* and *suites* in **risk group SM**.

## Flytowers, walkways and similar structures serving non-sleeping area firecells

**4.13.9** Intermittently occupied structures such as flytowers, walkways, maintenance platforms, ladders, and gantries that are not used by the public are not required to be *fire rated* provided no more than 10 persons have access concurrently.

## Basement floors

**4.13.10** *Basement firecells* shall be separated from one another, and from the lowest *firecell* above ground level, by *fire separations* having *FRRs* in accordance with Paragraph 2.3.

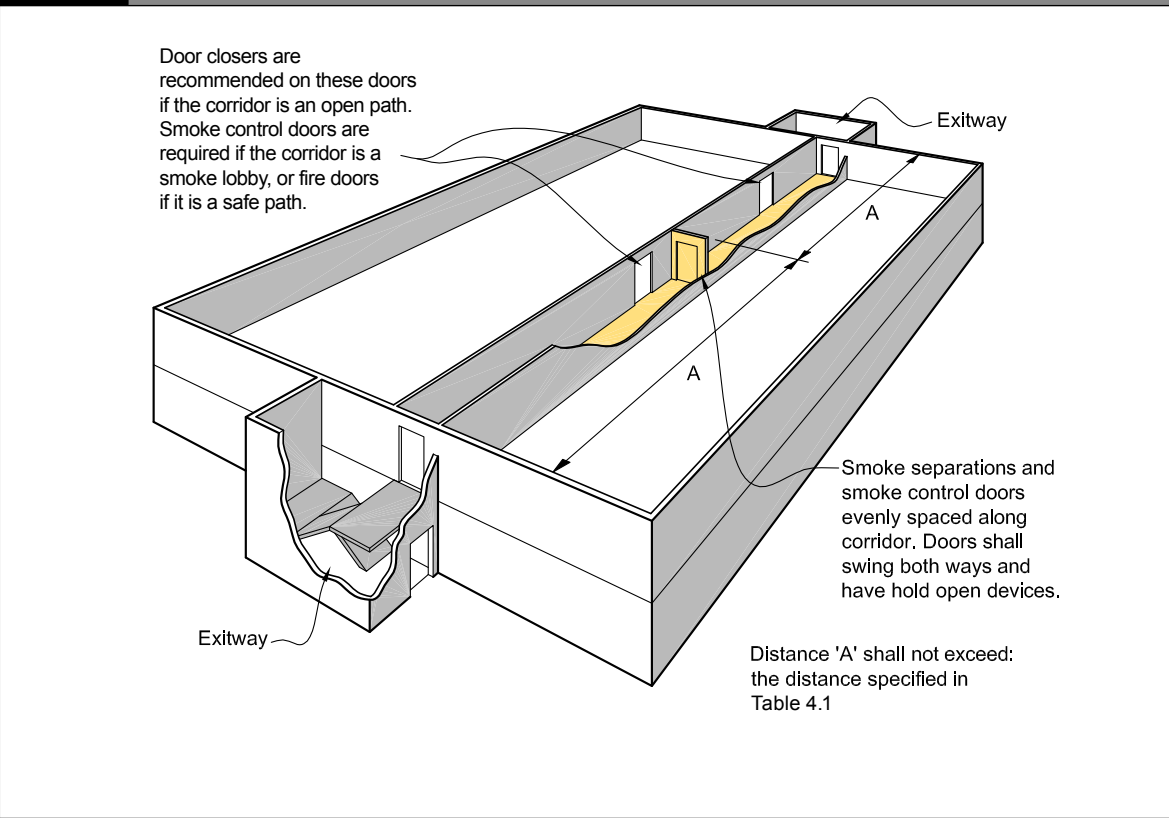
## 4.14 Subfloor spaces

**4.14.1** In *buildings* with an unoccupied subfloor space between the ground and lowest floor (see Figure 4.10), the floor shall have an *FRR* in accordance with Paragraph 2.3 except that no *FRR* is required if the following conditions are satisfied:

- a) Vertical *fire separations* and *external walls* extend down to ground level and enclose the space, and
- b) Access is available only for intermittent servicing of plumbing, drainage or other static services, and
- c) The space is not used for storage and does not contain any installation such as machinery or heating appliances which could create a *fire hazard*, except when *fire separated* from the rest of the subfloor space and the floor level above.

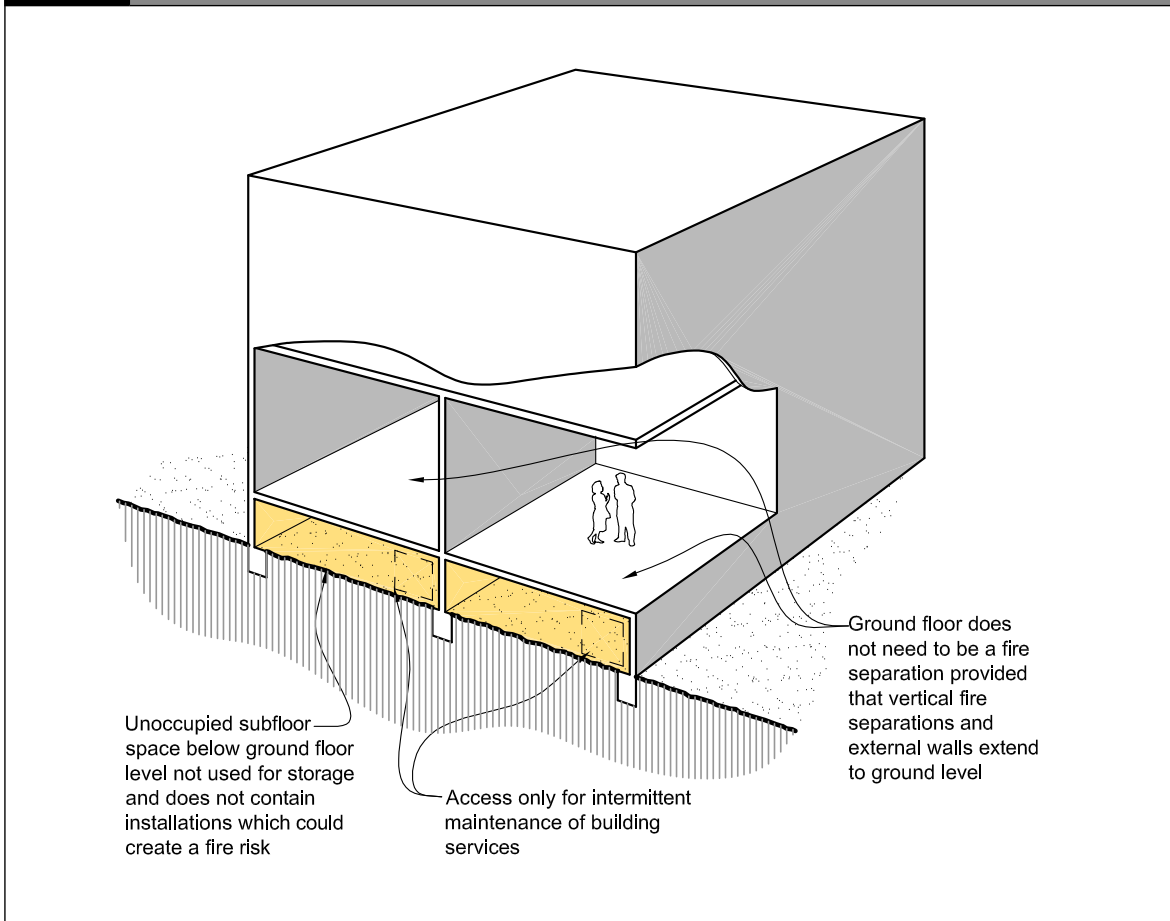


**Figure 4.9** Long corridor subdivision  
Paragraph 4.12.1 and 4.16.8



Amend 2  
Nov 2020

Figure 4.10 Subfloor spaces  
Paragraph 4.14.1



## 4.15 Concealed spaces

**4.15.1** The spread of fire in *concealed spaces* and cavities shall be avoided by ensuring that voids do not pass from one *firecell* to another, and by blocking off smaller voids with *cavity barriers* or, where appropriate, by using *fire stops* (see Paragraph 4.4).

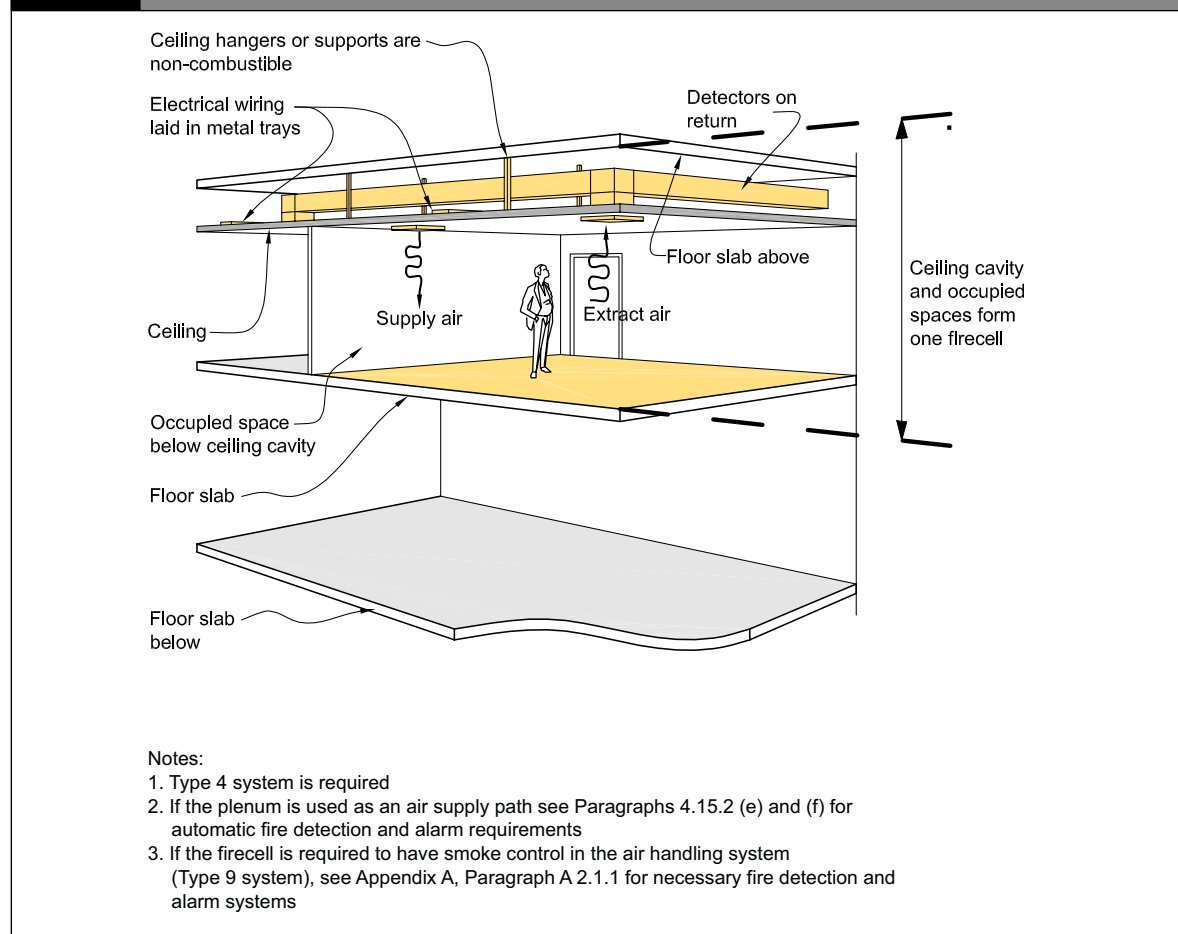
### Concealed spaces within firecells

**4.15.2** An upper *concealed space* may be used as an air handling plenum (see Figure 4.11) if the following requirements are satisfied:

- The upper *concealed space* does not extend into another *firecell*, and
- The ceiling and its supports and surfaces within the *concealed space* are *non-combustible*, and

- Electrical wiring is supported clear of the ceiling members and other equipment, and
- Any material used such as pipe insulation or acoustic insulation complies with the requirements of Table 4.4, and
- Where the air handling plenum is used as an air supply path, a Type 4 alarm system is installed with detectors in all return air ducts, and
- Where the air handling plenum is used as an air supply path, detector activation causes the ventilation system to shut down as required by Paragraph 4.18.1.

**Figure 4.11** Concealed spaces within firecells  
Paragraph 4.15.2



### Cavity barriers in walls and floors

**4.15.3** Any *concealed space* which may be a path for *fire spread* within internal walls or floors which are *fire separations*, or within *external walls*, shall have *cavity barriers* or be *fire stopped* (see Paragraph 4.4) at all common junctions (see Figures 4.3 and 4.4).

#### Exceptions to cavity barrier requirements

**4.15.4** *Cavity barriers* are not required below a floor next to the ground if the *concealed space* is:

- a) Less than 1.0 m in height, or
- b) Not normally accessed and has no openings through which litter can accumulate.

Amend 2  
Nov 2020

#### Cavity barrier construction

**4.15.5** *Cavity barriers* shall:

- a) Not reduce the *FRR* required for the element within which they are installed, and
- b) Where practical, be tightly fitted and mechanically fixed to rigid *construction*, but if this is not possible gaps shall be *fire stopped*, and
- c) Be fixed in a way that avoids impairment of their *fire separation* function as a result of:
  - i) *building* movement due to subsidence, shrinkage or thermal change, or
  - ii) collapse or failure of their components or fixings, or of abutting materials and any *penetrations* during a *fire*.

### Restriction of roof and ceiling space areas in unsprinklered firecells

**4.15.6** For **risk groups SM** and **CA**, unsprinklered *firecells*, roof space and ceiling space areas shall be subdivided by *fire separations* to prevent the hidden spread of *fire*.

Any space between ceilings and roofs or floors above shall not exceed:

- a) 400 m<sup>2</sup> in area, measured at ceiling level, or
- b) 30 m in either length or width.

This requirement does not apply where the ceiling space is a separate *firecell*. In

**CA** **risk group CA** only, subdivision may be substituted for detection in accordance with NZS 4512.

**4.15.7** The *fire separations* used for subdivision shall have an *FRR* in accordance with Paragraph 2.3 and shall extend from the ceiling to the underside of the external roof cladding or floor above. Any gaps shall be *fire stopped* as specified in Paragraph 4.4.

**4.15.8** If openings in the *fire separations* are required for service access or any other reason, they shall be fitted with *fire resisting closures*. Gaps around service *penetrations* shall be *fire stopped*.

**Figure 4.12** Curtain wall  
Paragraph 4.15.3 and 4.5.5

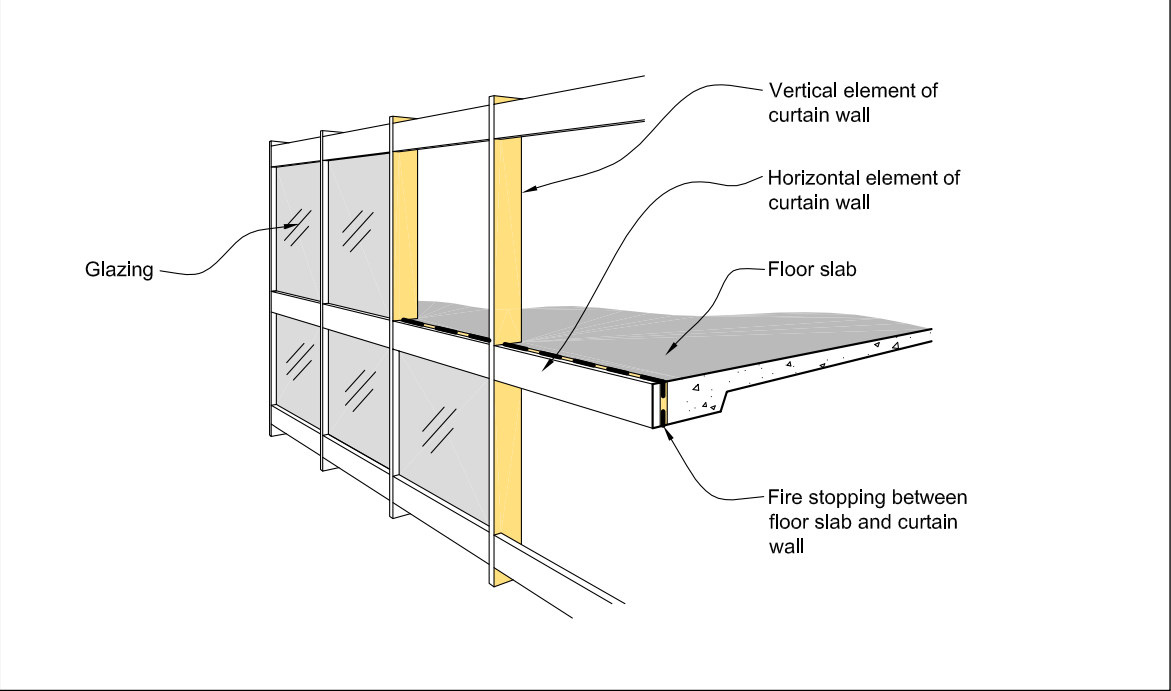


Table 4.2 Insulation and smoke stop capability of closures in fire and smoke separations Paragraph 4.16		
Risk group	Unsprinklered	Sprinklered
SM	-*/30sm	-*/-sm
SI		-*/-sm
CA	-*/30sm	-*/-sm
WB	-*/30sm	-*/-sm
WS		-*/-sm
VP	-*/30sm	-*/-sm

**Notes:**  
 Except as permitted by Paragraphs 4.16.11 – 4.16.13.  
 \* Integrity value of the life rating or property rating as required by this Acceptable Solution.

Amend 2  
Nov 2020

## 4.16 Closures in fire and smoke separations

Amend 2  
Nov 2020

**4.16.1** If activities within a *building* require openings in *fire separations* or *smoke separations* (e.g. for the passage of people, goods, services or light), closures to those openings shall have the *insulation* and smoke control performance as required by Table 4.2, in addition to the integrity performance as required by Table 2.4.

**4.16.2** *Doorsets* which are required to be:

- Fire doors* shall comply with Appendix C C6.1.1,
- Smoke control doors* shall, except as allowed by Paragraph 4.16.3, comply with Appendix C C6.1.2, and
- Fire doors* with smoke control capability shall comply with both a) and b).

**4.16.3** *Doorsets* installed in *fire separations* between *firecells* and vertical *safe paths* or *protected shafts* shall have smoke seals on all edges, except that smoke seals may be omitted:

- At the sill of *doorsets*, and
- For lifts, if either:
  - the *firecell* is sprinklered and has an automatic smoke detection system, or
  - a *smokecell* is placed between the doors and the rest of the *firecell*, other than when the lift shaft is permitted to be in the vertical *safe path*.

### Fire door and smoke control door installation

**4.16.4** *Fire doors* and *smoke control doors* shall be installed in accordance with Paragraph 3.15.

### Doorset markings

**4.16.5** *Doorsets* shall be clearly marked to show their *FRR* and, if required, to show their smoke stopping capability. Other signage requirements shall be as specified in Paragraph 3.16.

**4.16.6** Markings and labelling shall, in all other respects, comply with NZS 4520.

### Glazing in doors

**4.16.7** Glazing in *fire doors* and *smoke control doors* shall comply with Paragraph 4.2.

### Smoke control doors

**4.16.8** *Smoke control doors* complying with Paragraphs 4.16.2 to 4.16.7 shall be provided:

- a) At *smoke separations* in vertical *safe paths*, and
  - b) Where a corridor or an *escape route* passes through a *smoke separation* (see Figure 4.9), and
  - c) Between an *open path* and a *smoke lobby* (see Figure 4.13).
- Amend 2  
Nov 2020
- Amend 2  
Nov 2020

### Fire doors

**4.16.9** *Fire doors* shall be provided:

- a) Between an *open path* and a *safe path* (see Figures 4.13 and 4.14), and
  - b) Between a *smoke lobby* and a *safe path* (see Figure 4.13), and
  - c) Where the *escape route* passes through a *fire separation* (see Figure 4.14) or into an adjoining *building* (see Figure 3.10), and
  - d) Where the *escape route* passes through a *fire separation* which isolates the *safe path* from levels below the *final exit* (see Figure 4.15), and
  - e) In *fire separations* between vertical and horizontal portions of internal *safe paths*.
- Amend 2  
Nov 2020
- Amend 2  
Nov 2020
- Amend 2  
Nov 2020

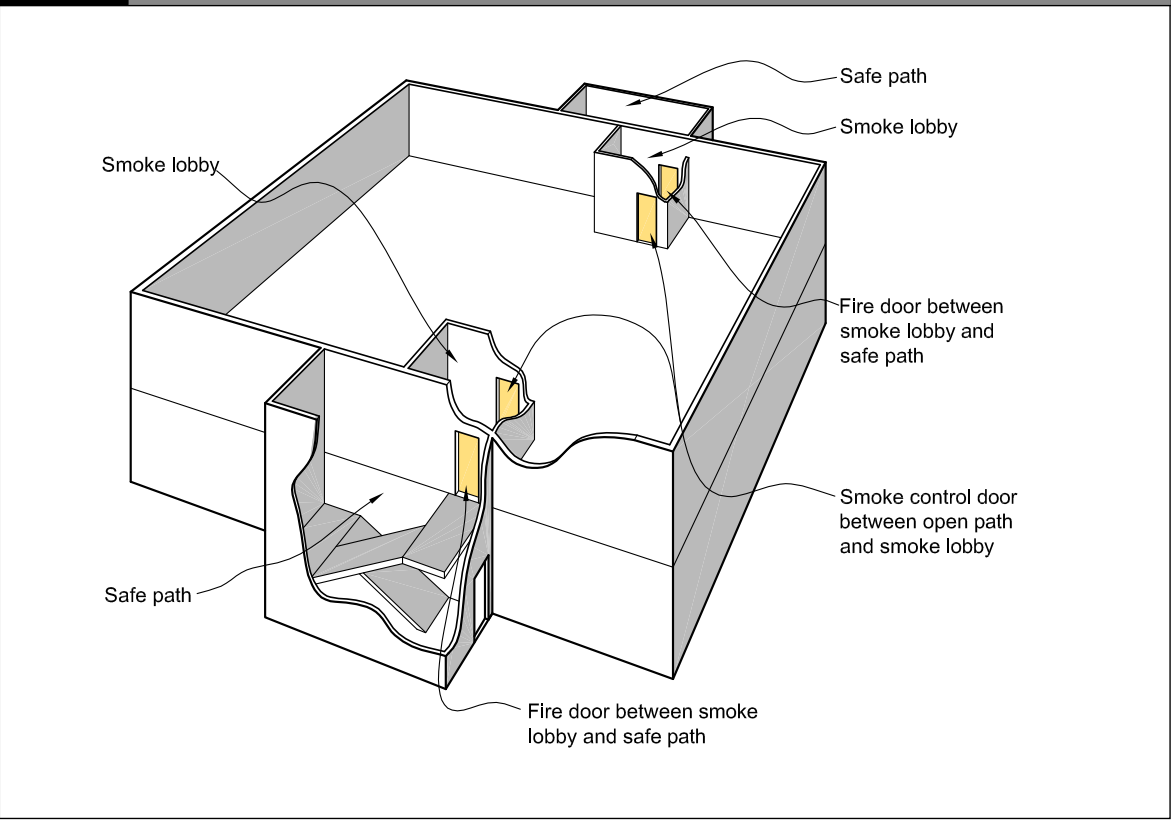
Amend 2  
Nov 2020

Amend 2  
Nov 2020



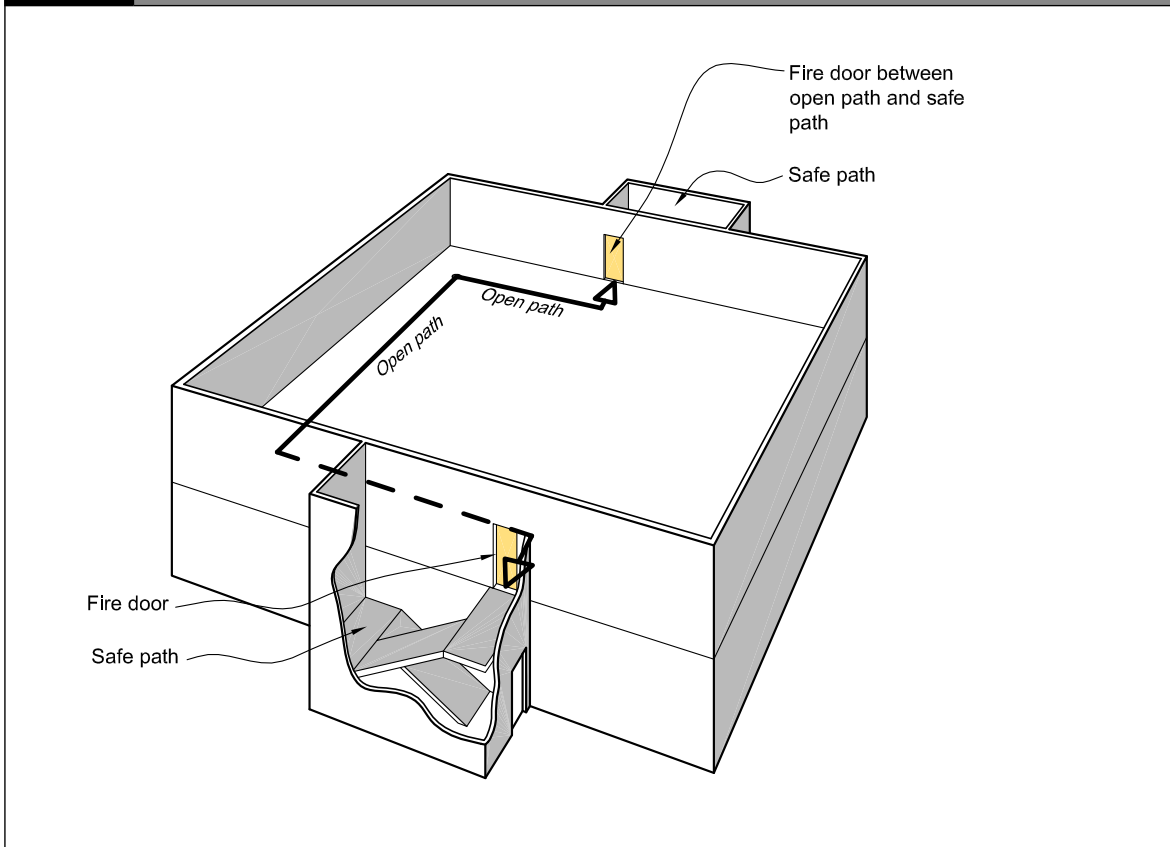
Amend 2  
Nov 2020

**Figure 4.13** Fire doors and smoke control doors  
Paragraphs 4.16.8 and 4.16.9



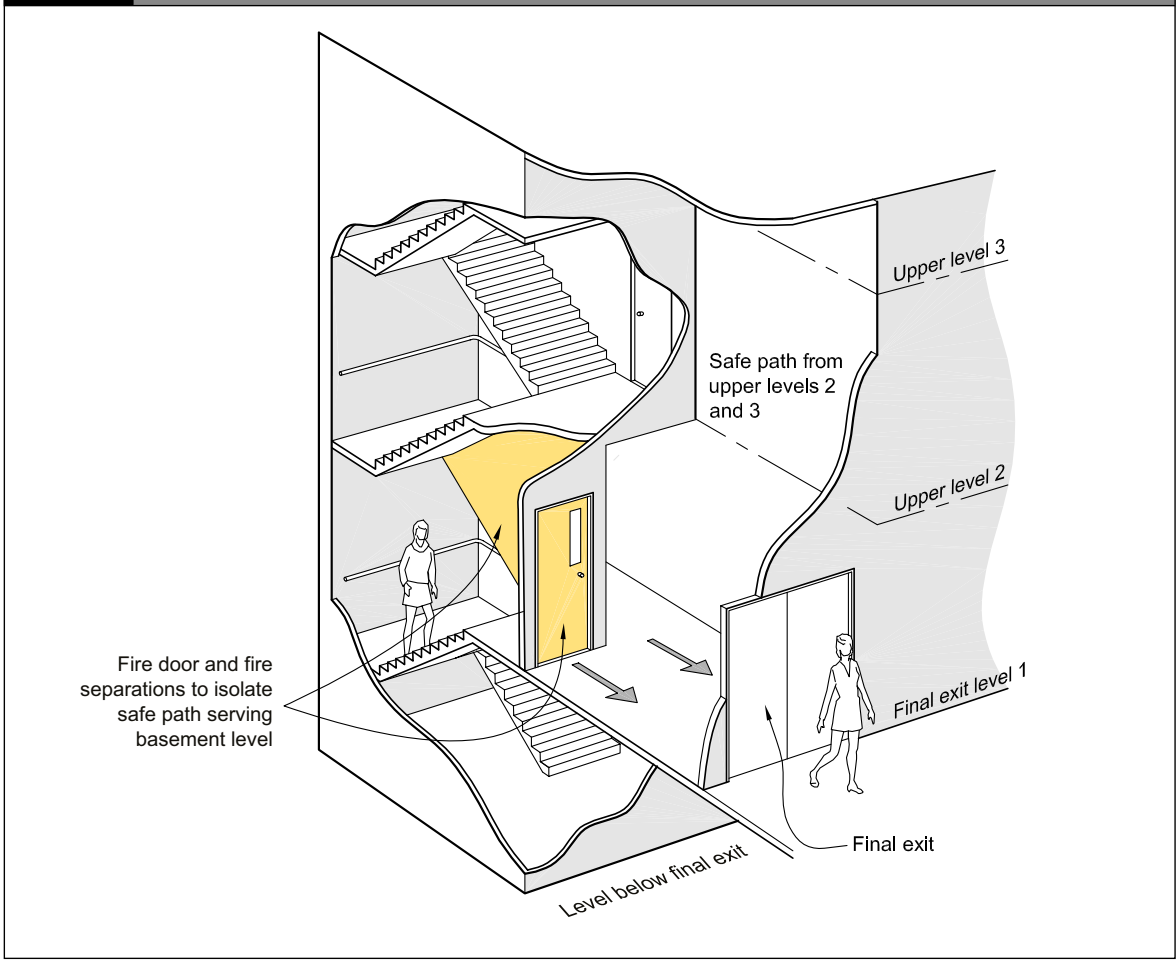
Amend 2  
Nov 2020

**Figure 4.14** Fire doors  
Paragraph 4.16.9



Amend 2  
Nov 2020

**Figure 4.15** Fire doors to separate floors above and below final exit level  
Paragraph 4.16.9 d)



**Protected shaft access panels**

**4.16.10** Access panels to *protected shafts* shall have the *fire* resistance performance as required by Paragraph 4.16.1 and shall be capable of being opened only with a special tool.

**Lift landing doors**

**4.16.11** Other than where Paragraph 3.10.3 for a passenger lift within a vertical *safe path* applies, *doorsets* for lift landing doors opening into lift shafts which are *protected shafts* shall be *fire doors* complying with Paragraphs 4.16.1 to 4.16.3 except that an *insulation* rating is not required. Lift landing doors need not be *fire* rated from the shaft side.

**Fire and smoke dampers**

**4.16.12** Any duct (unless fully enclosed by *construction* with an *FRR* no less than required for the *fire separation*) that passes through a *fire separation* shall not reduce the *fire* resistance of the *construction* through which the duct passes. Where a *fire damper* is used to maintain the required *fire* resistance it shall:

- a) Comply with AS 1682.1 and AS 1682.2, and
- b) Have a *fire integrity* and *insulation* rating no less than that of the *fire separation*, except that the *damper blade* is not required to have an *insulation* rating if the *building* is sprinkler protected or means are provided to prevent *combustible* materials being placed closer than 300 mm to the *fire damper* and air duct, and
- c) Be readily accessible for servicing.

**4.16.13** Where evacuation is delayed, ventilation ducts that pass through a *fire separation* to a *place of safety* within the *building* must be provided with a *smoke damper*.

**4.16.14** Where a *smoke damper* is used to maintain the *smoke separating* function, it shall comply with AS 1682.1 and AS 1682.2 and be actuated on alarm activation.

**Fire shutters**

**4.16.15** A service opening in a *fire separation* (for stairs, conveyor, forklift access or similar installation) which is not used as part of an *escape route* may be fitted with a *fire shutter*.

**4.16.16** The *fire shutter* shall be automatically activated by a signal from a smoke detector.

**4.16.17** A *fire shutter* shall include a device to retard the rate of closing to no more than 150 mm per second.

**4.17 Interior surface finishes, floor coverings and suspended flexible fabrics****Surface finish requirements for walls and ceilings**

**4.17.1** *Surface finish* requirements shall be as specified in Table 4.3 for walls and ceilings.

**Foamed plastics and combustible insulating materials**

**4.17.2** If *foamed plastics building materials* or *combustible insulating materials* form part of a wall or ceiling system, the completed system shall achieve a *Group Number* as specified in Table 4.3 and the *foamed plastics* shall comply with the flame propagation criteria as specified in AS 1366 Parts 1–4 for the material being used. This requirement does not apply to *building elements* listed in Paragraph 4.17.6.

**Flooring**

**4.17.3** Flooring shall be either *non-combustible* or, when tested to ISO 9239-1, shall have a critical radiant flux of not less than that specified in Table 4.5 (refer to Appendix C2.1).

**4.17.4** Paragraph 4.17.3 shall apply to flexible finishes such as carpets, vinyl sheet or tiles, and to finished or unfinished floor surfaces.

## Wood and wood products in floors

**4.17.5** In addition to the requirements of Paragraph 4.17.3, where floors in multi-storey *buildings* are *fire separations* and where the flooring material is made of wood products (which include boards manufactured from wood fibres or chips bound by an adhesive) the flooring material shall have either a thickness of no less than nominally 20 mm, or the floor assembly shall have an *FRR* of -/30/30 when exposed to *fire* from the flooring side.

### Exceptions to surface finish requirements

**4.17.6** *Surface finish* requirements do not apply to:

- a) Small areas of non-conforming product within a *firecell* with a total aggregate surface area not more than 5.0 m<sup>2</sup>, or
- b) Electrical switches, outlets, cover plates and similar small discontinuous areas, or
- c) Pipes and cables used to distribute power or services, or
- d) *Handrails* and general decorative trim of any material such as architraves, skirtings and window components, including reveals, provided these do not exceed 5% of the surface area of the wall or ceiling they are part of, or
- e) *Damp-proof courses*, seals, caulking, flashings, thermal breaks and ground moisture barriers, or
- f) Timber joinery and structural timber *building elements constructed* from solid wood, glulam or laminated veneer lumber. This includes heavy timber columns, beams, portals and shear walls not more than 3.0 m wide, but does not include exposed timber panels or permanent formwork on the underside of floor/ceiling systems, or
- g) Individual *doorsets*, or
- h) Continuous areas of permanently installed openable wall partitions having a surface area of not more than 25% of the divided room floor area or 5.0 m<sup>2</sup>, whichever is less, or
- i) *Marae buildings* using traditional Māori *construction* materials (eg, tukutuku and toetoe panels), or

- CA** j) In *risk group CA* only, uniformly distributed roof lights where:
- i) the total area does not exceed 15% of the ceiling area (in plan), and
  - ii) the minimum floor to ceiling height is not less than 6.0 m, and
  - iii) the roof lights achieve a *Group Number* not greater than 3.

### CA Educational buildings

**4.17.7** Unsprinklered *firecells* containing classrooms, passageways and corridors of educational *buildings* need not comply with Table 4.3 provided all the following conditions are satisfied:

- a) The *occupant load* is less than 250, and
- b) The *firecells* are at ground floor level and are served by at least two *exitways* or *final exits*, and
- c) The material *Group Number* is no more than 2–5 for surfaces 1.2 m or more above floor level, and
- d) The material *Group Number* is no more than 3 for surfaces less than 1.2 m above floor level.

### Suspended flexible fabrics

**4.17.8** When tested to AS 1530.2, suspended flexible fabrics shall, within all *occupied spaces* including *exitways*:

- a) Have a *flammability index* of no greater than 12, and
- b) When used as underlay to roofing or exterior cladding that is exposed to view, have a *flammability index* of no greater than 5.

### Membrane structures

**4.17.9** The fabric of structures such as tents, marquees or canopies shall be tested to AS 1530.2 and shall achieve a *flammability index* of no greater than 12.

**4.17.10** The requirements for membrane structures need not apply to small *occupant loads* such as camping tents and horticultural applications.



## Building services

**4.17.11** Where air ducts are contained wholly within a *protected shaft*, provided the shaft does not also contain lifts, only the interior *surface finish* of the air duct is required to comply with Table 4.4.

**4.17.12** The surfaces of *building services* shall be as per Table 4.4.

## Trampers' huts

**4.17.13** In trampers' huts (that are not *backcountry huts* as defined in BCH/AS1) used for overnight accommodation in remote locations, wall and ceiling linings with a maximum *Group Number* of 3 are acceptable provided that:

- a) The *occupant load* is no greater than 20, and
- b) All sleeping spaces have no fewer than two *escape routes*.

## 4.18 Building services plant

**4.18.1** Where smoke control in air handling systems is required to prevent the recirculation of smoke through an air handling system to other *firecells* in a *building*, these systems shall be as specified in Appendix A A2.1.

Amend 2  
Nov 2020

<b>Table 4.3</b>		<b>Internal surface finishes</b> Paragraph 4.17				
Fire protection	Maximum permitted Group Number					
	Exitways and Importance Level 4 buildings: walls and ceilings	Sleeping spaces where care or detention is provided: walls and ceilings	Other sleeping spaces (excluding within household units) and crowd spaces: ceiling surfaces	Other sleeping spaces (excluding within household units) and crowd spaces: wall surfaces	All other occupied spaces: walls and ceilings	
Unsprinklered	1-5	1-5	2-5	2-5	3	
Sprinklered	2	2	2	3	3	

Amend 2  
Nov 2020

<b>Table 4.4</b>		<b>Surfaces of building services</b> Paragraphs 4.17.11 and 4.17.12	
Building services	Maximum permitted Group Number		
	Spaces not protected with an automatic fire sprinkler system	Spaces protected with an automatic fire sprinkler system	
Internal faces of ducts for HVAC systems and kitchen exhaust ducts <sup>1</sup>	1-5	2	
External faces of ducts, acoustic treatment and pipe insulation within exitways <sup>1</sup>	1-5	2	
Acoustic treatment and pipe insulation within sleeping uses	3	3	
External faces of ducts for HVAC systems <sup>1</sup>	3	3	

**Notes:**

1. Surfaces of rigid and flexible ductwork for HVAC systems may be assigned a material *Group Number* of 1-5 when the ductwork complies with the *fire hazard* properties set out in AS 4254.

Table 4.5 Critical radiant flux requirements for flooring (kW/m <sup>2</sup> ) Paragraph 4.17.3						
Risk group	Area of building					
	Exitways in all buildings and sleeping areas and treatment rooms in risk group SM, SI		Non-sleeping firecells accommodating more than 50 people		All other occupied spaces, other than household units	
	Sprinklered	Unsprinklered	Sprinklered	Unsprinklered	Sprinklered	Unsprinklered
<b>SM</b>	2.2	2.2	1.2	2.2	1.2	1.2
<b>SI</b>	2.2	4.5	1.2		1.2	
<b>CA</b>	2.2	2.2	1.2	2.2	1.2	1.2
<b>WB</b>	2.2	2.2	1.2	2.2	1.2	1.2
<b>WS</b>	2.2		1.2		1.2	
<b>VP</b>	2.2	2.2	1.2	2.2	1.2	1.2

# Part 5: Control of external fire spread

## CONTENTS

- 5.1 Fire separation for buildings with more than one title
- 5.2 Horizontal fire spread from external walls
- 5.3 FRRs of external walls
- 5.4 Small openings and fire resisting glazing
- 5.5 Table method for external walls
- 5.6 Horizontal fire spread from roofs and open sided buildings
- 5.7 Vertical fire spread
- 5.8 External cladding systems

### 5.1 Fire separation for buildings with more than one title

5.1.1 Where a *building* is subdivided so that it straddles more than one title, it shall be separated from:

- a) The part of the *building* on an adjacent title by *fire separations* having an *FRR* meeting the *property rating* in accordance with Paragraph 2.3, and
- b) Any external area in common, unless Paragraph 5.1.2 applies, by *external walls* complying with Paragraph 5.3 except that, if roofed, the area in common shall be a *firecell* separated from adjacent titles by *fire separations* meeting the *property rating* in accordance with Paragraph 2.3.

5.1.2 Where a *building* is subdivided (as in Paragraph 5.1.1 a)), and all the titles and any areas in common are sprinklered, the requirements for *fire separations* of Paragraph 5.1.1 b) need not apply. However, the requirements for separation of *exitways* in Paragraphs 4.9.2 and 4.9.3, and sleeping areas in Paragraph 4.6 shall still apply.

**VP** 5.1.3 Refer to Paragraph 4.1.2 for allowances in vehicle parking areas of *buildings* separated into multiple titles.

### 5.2 Horizontal fire spread from external walls

#### Separation

5.2.1 Specific separation requirements for *unprotected areas* in *external walls* shall be applied in the following circumstances:

- a) If, due to the configuration of a single *building* or the siting of other *buildings* on the same property, *external walls* of adjacent *firecells* are exposed to each other at an angle of less than 90°, and one or both *firecells* contain sleeping *risk groups* or *exitways*, or
- b) If there are *unprotected areas* in *external walls* facing a *relevant boundary* to other *property* at an angle of less than 90°.

5.2.2 Protection shall be achieved by using one or more of the following approaches:

- a) Provide a sprinkler system complying with NZS 4541 with a Class A or Class B2 water supply. This dispensation does not apply to parts of the *external wall* within 1.0 m of the *relevant boundary*, or where the *external wall* is of a *firecell* used for storage with a storage height greater than 3.0 m, or
- b) Distance separation (refer to Paragraph 5.5), or
- c) Limiting *unprotected areas* in *external walls* (refer to Paragraph 5.5), or
- d) Using *fire resisting glazing* (refer to Paragraph 5.4).



**5.2.3** Where the intersection angle of the *building* and the *relevant boundary* is 90° or greater, there are no requirements and an *unprotected area* of 100% is permitted for the *external wall*.

**5.2.4** If a wall or part of a wall is less than 1.0 m from the *relevant boundary*, a combination of small *unprotected areas* and *fire resisting glazing* is permitted as detailed in Paragraph 5.4.

**5.2.5** Table 5.2 applies only to the permitted *unprotected area* in *external walls* 1.0 m or more from the *relevant boundary*. This can be combined with the areas of *fire resisting glazing* and small *unprotected areas* in Paragraph 5.4.

**5.2.6** Regardless of the method adopted, all parts of an *external wall* other than allowable *unprotected areas* shall have the appropriate *FRR* as specified by the relevant parts of this Acceptable Solution.

#### Analysis required for all external walls

**5.2.7** The analysis shall be done for all *external walls* of the *building* to check the permitted *unprotected area* in each wall.

#### Notional boundary – firecells on the same property

**5.2.8** For specific separation requirements for *unprotected areas* in *external walls* of *firecells* in the same *building*, or in separate *buildings* on the same property, a *notional boundary* shall be used instead of the *relevant boundary*. In such cases, when applying Tables 5.1, 5.2 and 5.3, the words *relevant boundary* shall be interpreted as *notional boundary*.

**5.2.9** Where one or both *firecells* on the same property contain sleeping *risk groups* or *exitways*, analysis shall be done separately for each *firecell* with respect to the same *notional boundary*.

## 5.3 FRRs of external walls

**5.3.1** *Building elements* that are part of an *external wall* that is required to be *fire rated* shall be *fire rated* as required by Paragraph 2.3. If a *safe path* has an *external wall*, that wall may be 100% unprotected provided any walls between the *safe path* and adjacent *firecells* have an *FRR* determined using the *property rating*.

**5.3.2** Any part of an *external wall* enclosing a *firecell* and not permitted to be an *unprotected area* shall have an *FRR* in accordance with Paragraph 2.3. If the *external wall* is less than 1.0 m from the *relevant boundary* the wall shall be *fire rated* to protect from both directions.

**5.3.3** When the *unprotected area* of an *external wall* is permitted to be 100%, but the *primary elements* in the line of that wall are required to be *fire rated*, the rating of those *primary elements* shall be no less than the *life rating* in accordance with Paragraph 2.3.

## 5.4 Small openings and fire resisting glazing

**5.4.1** *External wall construction* shall meet the following requirements:

- a) Small *unprotected areas* no greater than 0.1 m<sup>2</sup> (referred to as Type A areas) and areas of *fire resisting glazing* (referred to as Type B areas) shall be located to comply with Figure 5.1, and
- b) The remainder of the wall shall be *fire rated* in accordance with Paragraph 5.5.

Amend 2  
Nov 2020

**5.4.2** The *fire resisting glazing* shall be rated for *integrity*, and the *FRR* of both the glazing and the *external wall* shall be in accordance with Paragraph 2.3.

Amend 2  
Nov 2020

#### Size and spacing of Type A and Type B areas

**5.4.3** Type A areas shall be no greater than 0.1 m<sup>2</sup>. Type B areas shall be no greater than permitted by Table 5.1 according to the distance from the *relevant boundary*.

Amend 2  
Nov 2020

**5.4.4** There is no limitation on the spacing between adjacent Type A and Type B areas which occur in different *firecells*. Within a *firecell* the following requirements shall apply (refer to Figure 5.1):

- a) Type A areas shall be no closer, both vertically and horizontally, than 1.5 m to another Type A or to a Type B area,
- b) Type B areas shall be no closer to one another, vertically or horizontally, than the dimensions X or Y shown on Figure 5.1, and
- c) Where Type B areas are staggered, rather than being aligned vertically or horizontally, the shortest distance, in any direction, between adjacent areas shall be no less than the greater of the X and Y measurements.

## 5.5 Table method for external walls

**5.5.1** The table method for *external walls* is a means of satisfying the requirements of this Acceptable Solution for the control of external *fire spread* and shall be applied to *external walls* of *buildings* which are parallel to or angled at less than 90° to the *relevant boundary*.

The maximum *unprotected area* for *external walls* shall be specified in:

- a) Table 5.2a for **risk groups SM** and **SI**, and
- b) Table 5.2b for **risk group CA**, and
- c) Table 5.2c for **risk group WB** professional activities, industrial activities, and intermittently occupied *buildings* and **risk group VP**, and
- d) Table 5.2d for **risk group WB** storage activities, and
- e) Table 5.2e for **risk group WS**.

Tables 5.2a, 5.2b, 5.2c, 5.2d and 5.2e are split into three parts according to the angle incident between the subject wall and the *relevant boundary* (see Figure 5.2 and Figure 5.3).

**5.5.2** The table method shall be used to determine the percentage of *unprotected area* in the *external wall* of each *firecell* depending on the distance to the *relevant boundary* from the closest *unprotected area*.

**5.5.3** Tables 5.2a, 5.2b, 5.2c, 5.2d and 5.2e can also be used to determine the required distance from the *relevant boundary* to the closest *unprotected area* where the percentage of *unprotected area* has previously been determined. Select the appropriate percentage (under the rectangle width column) and read the permitted distance to the *relevant boundary* from the left hand column of Table 5.2.

**5.5.4** Tables 5.2a, 5.2b, 5.2c, 5.2d and 5.2e do not contain the exact measurements for the *firecell* being considered, use the next highest value for percentage area or next lowest value for *boundary distance*.

**5.5.5** The largest individual *unprotected area* in the *external wall* and distance to any adjacent *unprotected areas* shall be restricted to the maximum dimensions specified in Table 5.3 (for the applicable *risk group*).

**5.5.6** In **risk groups CA, WB, WS** and **VP**, where the *firecell* is wider than 30 m, the *external wall* shall be divided into a number of 30 m widths and each of these can be assessed separately when considering the size of the largest individual *unprotected area* specified in Table 5.3.

**5.5.7** As an alternative to the table method, C/VM2 Appendix C: Methodology for design scenario HS: Horizontal fire spread (Tabular Data) can be used. For the C/VM2 Appendix C method, the *unprotected area* tables and the wing/return wall tables must be used together.

Amend 2  
Nov 2020

Amend 2  
Nov 2020

Amend 2  
Nov 2020

Amend 2  
Nov 2020

Amend 2  
Nov 2020

<b>Table 5.1</b>		<b>Maximum permitted areas of fire resisting glazing (m<sup>2</sup>)</b> Paragraph 5.4.2						
Minimum distance to relevant boundary (m)	Risk groups							
	SM <sup>1</sup>	CA		WB & VP Professional activities, industrial activities, and intermittently occupied building and risk group VP		WB Storage activities		WS
	Un-sprinklered	Un-sprinklered	Sprinklered	Un-sprinklered	Sprinklered	Un-sprinklered	Sprinklered	Sprinklered
0.0	1.0	1.0	5.0	1.0	5.0	1.0	1.0	1.0
0.1	1.0	1.0	6.5	1.0	6.0	1.0	1.0	1.0
0.2	1.0	1.0	7.5	1.0	7.5	1.0	1.0	1.0
0.3	1.0	1.0	9.0	1.0	9.0	1.0	1.0	1.0
0.4	1.0	1.0	10.0	1.0	10.0	1.0	1.5	1.5
0.5	1.5	1.0	11.0	1.0	11.0	1.0	2.5	2.5
0.6	2.0	1.0	13.0	1.0	13.0	1.0	3.5	3.5
0.7	3.0	1.5	14.0	1.5	14.0	1.0	5.0	5.0
0.8	3.5	2.0	15.0 <sup>3</sup>	2.0	15.0 <sup>3</sup>	1.0	6.5	6.5
0.9	5.0	3.0		2.5		1.5	7.5	7.5
1.0	6.0	3.5		3.5		1.5	8.5	8.5
1.1	7.5	4.5		4.0		2.0	9.5	9.5
1.2	8.5	5.5		5.5		2.5	10.0	10.0
1.3	10.0	7.0		7.0		3.0	11.0	11.0
1.4	12.0	8.0		8.0		3.5	12.0	12.0
1.5	13.0	8.5		8.5		4.0	13.0	13.0
1.6	14.0	9.5		9.5		5.0	14.0	14.0
1.7	15.0 <sup>2</sup>	10.0		10.0		5.5	15.0 <sup>3</sup>	15.0 <sup>3</sup>
1.8		10.0		10.0		6.0		
1.9		11.0		11.0		6.5		
2.0		12.0		12.0		7.0		
2.1		13.0		13.0		7.5		
2.2		14.0		14.0		8.0		
2.3		15.0 <sup>3</sup>		15.0 <sup>3</sup>		8.5		
2.4						9.0		
2.5						9.5		
2.6						10.0		
2.7						11.0		
2.8						11.0		
2.9						12.0		

Amend 2  
Nov 2020

↳ continued






**Table 5.1** Maximum permitted areas of fire resisting glazing (m<sup>2</sup>) /continued  
Paragraph 5.4.2

Amend 2  
Nov 2020

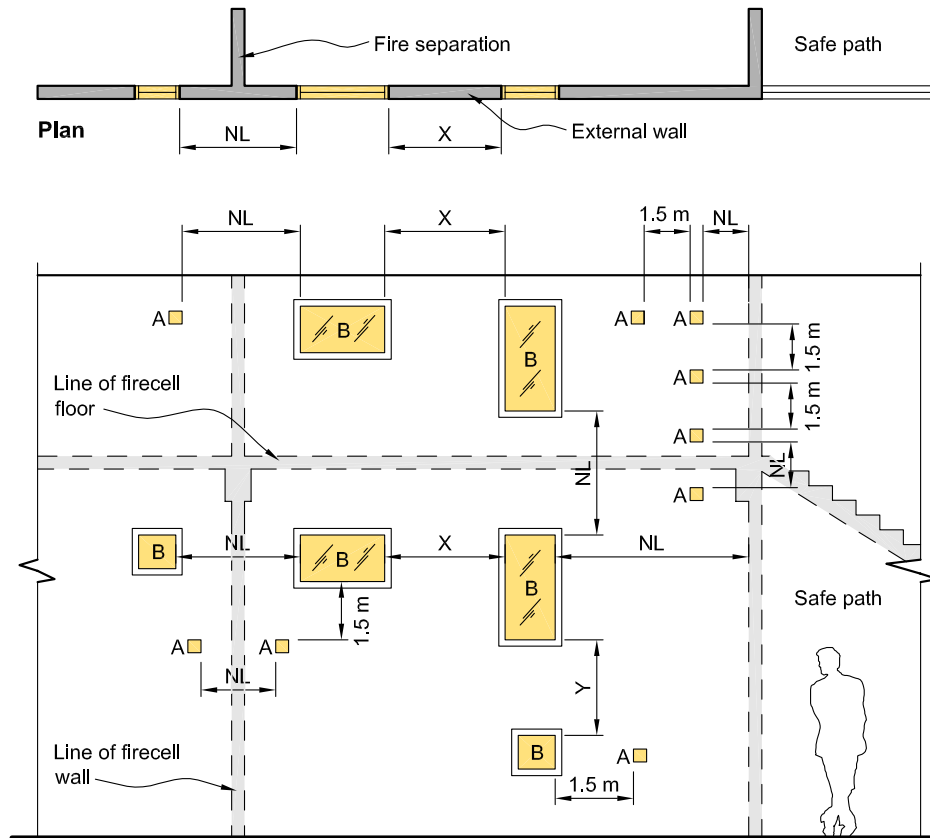
Amend 2  
Nov 2020

Minimum distance to relevant boundary (m)	Risk groups							
	SM <sup>1</sup>	CA		WB & VP		WB		WS
	Un-sprinklered	Un-sprinklered	Sprinklered	Un-sprinklered	Sprinklered	Un-sprinklered	Sprinklered	Sprinklered
3.0						12.0		
3.1						13.0		
3.2						14.0		
3.4						15.0 <sup>3</sup>		

**Notes:**

-  1. For sprinklered firecells in risk groups SM and SI there is no limit on the permitted area of fire resisting glazing.
- 
-  2. For unsprinklered firecells in risk group SM there is no limit on the permitted area of fire resisting glazing at distances greater than 1.7 m from the relevant boundary.
-  3. For all risk groups other than SM and SI the maximum permitted area of fire resisting glazing is 15 m<sup>2</sup>.
- 

**Figure 5.1** Method 1 – Permitted small unprotected areas and fire resisting glazing  
Paragraph 5.4.1 and 5.4.4



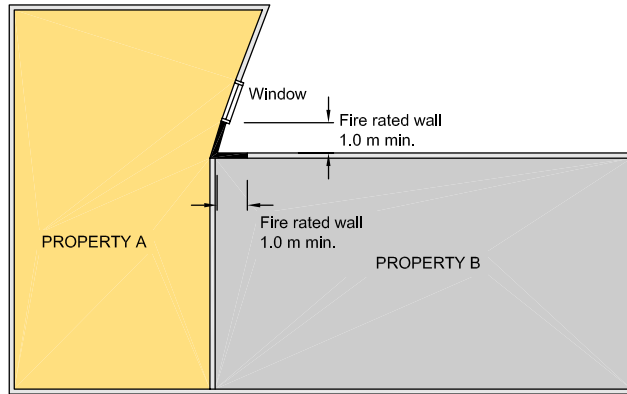
**Elevation**

**Dimensions shown are minimum distances between Type A unprotected areas and of Type B fire resisting glazing**

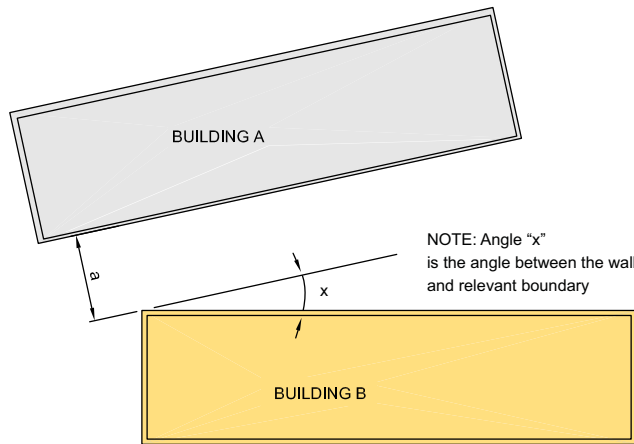
**Legend**

- A □ Type A *unprotected areas* of 0.1m<sup>2</sup> maximum
- ▣ Type B areas of fire resisting glazing complying with Table 5.1
- NL No limitation on spacing
- X Spacing to be no less than the greater of the widths of the two Type B areas being considered
- Y Spacing to be no less than the greater of the heights of the two Type B areas being considered

**Figure 5.2** Separation of unprotected areas  
Paragraph 5.5.1

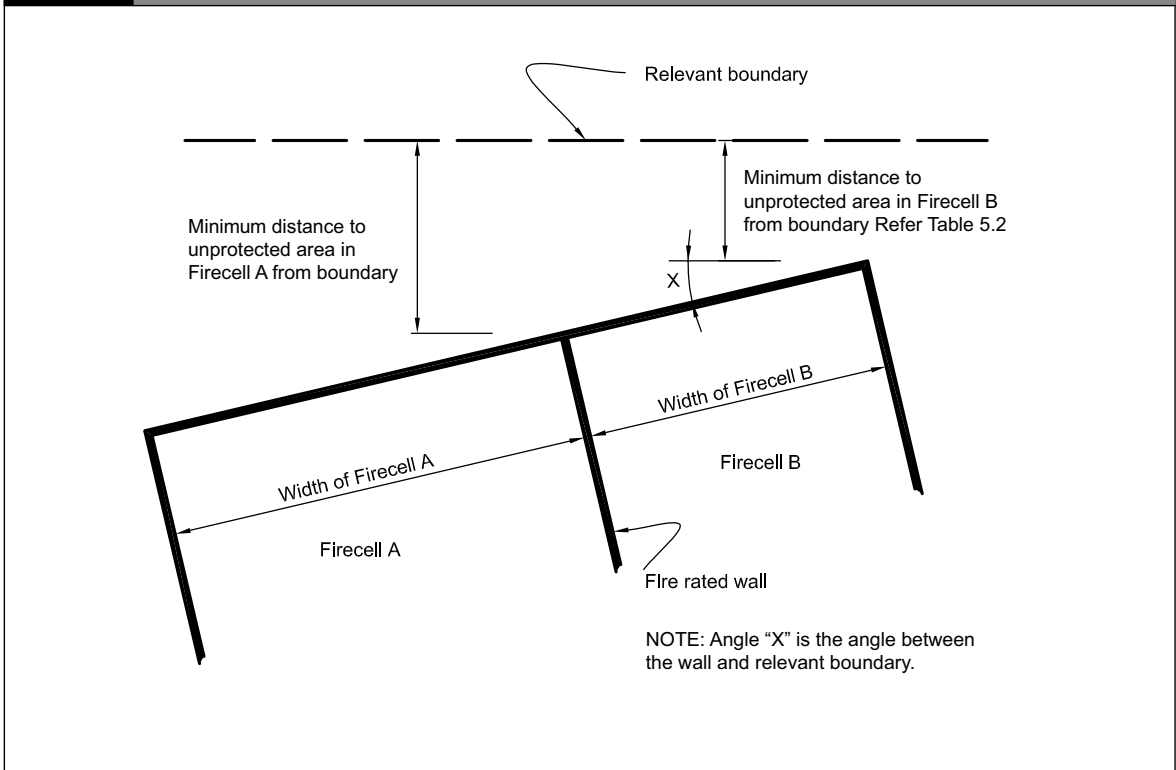


(a) ADJOINING FIRECELLS



NOTE: a = distance to other building  
(b) SEPARATE BUILDINGS

**Figure 5.3** Measuring distance to relevant boundary for use in Table 5.2  
Tables 5.2 and 5.3 and Paragraph 5.5.1



<b>Table 5.2a</b>		<b>Maximum percentage of unprotected area for external walls for risk groups SM and SI</b> Paragraphs 5.2.8, 5.5.1 a), 5.5.3, 5.5.4											
<b>Risk group</b>	<b>Minimum distance to relevant boundary (m)<sup>1</sup></b>	<b>Percentage of wall area allowed to be unprotected</b>											
		<b>Angle between wall and relevant boundary ≤ 45°</b>				<b>Angle between wall and relevant boundary &gt; 45° to ≤ 60°</b>				<b>Angle between wall and relevant boundary &gt; 60° to &lt; 90°</b>			
		<b>Width of unsprinklered firecell (m)</b>		<b>Width of sprinklered firecell (m)</b>		<b>Width of unsprinklered firecell (m)</b>		<b>Width of sprinklered firecell (m)</b>		<b>Width of unsprinklered firecell (m)</b>		<b>Width of sprinklered firecell (m)</b>	
		≤ 5	> 5	≤ 5	> 5	≤ 5	> 5	≤ 5	> 5	≤ 5	> 5	≤ 5	> 5
<b>SM</b>	<1	0	0	0	0	0	0	0	0	0	0	0	0
	1	35	30	70	60	45	33	90	66	55	35	100	70
	2	55	40	100	80	70	45	100	90	85	55		100
	3	80	55		100	95	65		100	100	80		
	4	100	70			100	90				100		
	5		90				100						
	6		100										
<b>SI</b>	<1			0	0			0	0			0	0
	1			70	60			90	66			100	70
	2			100	80			100	90				100
	3				100				100				

**Notes:**  
1. See Figure 5.3

Amend 2  
Nov 2020

Amend 2  
Nov 2020



<b>Table 5.2b</b>		<b>Maximum percentage of unprotected area for external walls for risk group CA</b> Paragraphs 5.2.8, 5.5.1 b), 5.5.3 and 5.5.4											
Risk group	Minimum distance to relevant boundary (m) <sup>1</sup>	Percentage of wall area allowed to be unprotected											
		Angle between wall and relevant boundary $\leq 45^\circ$				Angle between wall and relevant boundary $> 45^\circ$ to $\leq 60^\circ$				Angle between wall and relevant boundary $> 60^\circ$ to $< 90^\circ$			
		Width of unsprinklered firecell (m)		Width of sprinklered firecel (m)		Width of unsprinklered firecell (m)		Width of sprinklered firecel (m)		Width of unsprinklered firecell (m)		Width of sprinklered firecell (m)	
		$\leq 10$	$> 10$	$\leq 10$	$> 10$	$\leq 10$	$> 10$	$\leq 10$	$> 10$	$\leq 10$	$> 10$	$\leq 10$	$> 10$
CA	< 1	0	0	0	0	0	0	0	0	0	0	0	0
	1	20	20	40	40	20	20	40	40	23	20	46	40
	2	22	20	44	40	25	20	50	40	30	22	60	44
	3	25	25	50	50	30	25	60	60	39	25	78	50
	4	30	30	60	60	40	30	80	60	50	30	100	60
	5	40	30	80	60	50	30	100	60	64	40		80
	6	45	35	90	70	60	40		80	79	45		90
	7	55	40	100	80	70	45		90	90	55		100
	8	65	45		90	85	50		100	100	65		
	9	75	50		100	95	55				75		
	10	90	55			100	65				90		
	11	100	65				75				100		
	12		70				85						
	13		80				95						
	14		90				100						
	15		95										
16		100											

**Notes:**  
1. See Figure 5.3

Amend 2  
Nov 2020

<b>Table 5.2c</b>		<b>Maximum percentage of unprotected area for external walls for risk group WB professional activities, industrial activities, and intermittently occupied buildings and risk group VP</b> Paragraphs 5.2.8, 5.5.1 c), 5.5.3 and 5.5.4											
<b>Risk group</b>	<b>Minimum distance to relevant boundary (m)<sup>1</sup></b>	<b>Percentage of walls allowed to be unprotected</b>											
		<b>Angle between wall and relevant boundary ≤ 45°</b>				<b>Angle between wall and relevant boundary &gt; 45° to ≤ 60°</b>				<b>Angle between wall and relevant boundary &gt; 60° to &lt; 90°</b>			
		<b>Width of unsprinklered firecell (m)</b>		<b>Width of sprinklered firecell (m)</b>		<b>Width of unsprinklered firecell (m)</b>		<b>Width of sprinklered firecell (m)</b>		<b>Width of unsprinklered firecell (m)</b>		<b>Width of sprinklered firecell (m)</b>	
		≤ 10	> 10	≤ 10	> 10	≤ 10	> 10	≤ 10	> 10	≤ 10	> 10	≤ 10	> 10
	< 1	0	0	0	0	0	0	0	0	0	0	0	0
	1	20	20	40	40	20	20	40	40	25	20	50	40
	2	25	25	50	50	30	25	60	50	35	25	70	50
	3	30	30	60	60	40	30	80	60	40	30	80	60
	4	40	35	80	70	50	35	100	70	50	40	100	80
<b>WB</b>	5	50	40	100	80	65	40		80	60	50		100
<b>VP</b>	6	60	50		100	80	50		100	75	60		
	7	75	55			90	60			90	75		
	8	90	60			100	70			100	90		
	9	100	70				80				100		
	10		80				90						
	11		90				100						
	12		100										

**Notes:**  
1. See Figure 5.3

Amend 2  
Nov 2020

<b>Table 5.2d</b>		<b>Maximum percentage of unprotected area for external walls for risk group WB storage activities</b> Paragraphs 5.2.8, 5.5.1 d), 5.5.3 and 5.5.4					
Risk group	Minimum distance to relevant boundary (m) <sup>1</sup>	Percentage of wall area allowed to be unprotected					
		Angle between wall and relevant boundary $\leq 45^\circ$		Angle between wall and relevant boundary $> 45^\circ$ to $\leq 60^\circ$		Angle between wall and relevant boundary $> 60^\circ$ to $< 90^\circ$	
		Width of unsprinklered firecell (Any width)	Width of sprinklered firecell (Any width)	Width of unsprinklered firecell (Any width)	Width of sprinklered firecell (Any width)	Width of unsprinklered firecell (Any width)	Width of sprinklered firecell (Any width)
WB	< 1	0	0	0	0	0	0
	1	10	20	15	30	15	30
	2	15	30	15	35	15	35
	3	20	40	20	40	20	40
	4	20	45	25	50	25	50
	5	25	50	25	55	30	60
	6	30	60	30	60	35	70
	7	35	70	35	70	40	80
	8	40	80	45	90	50	100
	9	40	85	50	100	55	
	10	45	90	55		65	
	11	50	100	60		70	
	12	60		70		80	
	13	65		80		90	
	14	70		85		100	
15	100		100				

**Notes:**  
1. See Figure 5.3

Amend 2  
Nov 2020

<b>Table 5.2e</b>		<b>Maximum percentage of unprotected area for external walls for risk group WS</b> Paragraphs 5.2.8, 5.5.1 e), 5.5.3 and 5.5.4					
Risk group	Minimum distance to relevant boundary (m) <sup>1</sup>	Percentage of wall area allowed to be unprotected					
		Angle between wall and relevant boundary $\leq 45^\circ$		Angle between wall and relevant boundary $> 45^\circ$ to $\leq 60^\circ$		Angle between wall and relevant boundary $> 60^\circ$ to $< 90^\circ$	
		Width of sprinklered firecell (m)		Width of sprinklered firecell (m)		Width of sprinklered firecell (m)	
		$\leq 20$	$> 20$	$\leq 20$	$> 20$	$\leq 20$	$> 20$
WS	< 1	0	0	0	0	0	0
	1	20	20	25	20	25	20
	2	30	25	30	30	30	25
	3	30	30	35	30	35	30
	4	35	35	40	35	40	35
	5	40	40	45	40	50	40
	6	45	40	50	45	60	50
	7	50	50	60	50	70	60
	8	60	55	65	60	85	65
	9	65	60	80	65	100	75
	10	70	65	90	75		90
	11	80	70	100	80		100
	12	90	80		90		
	13	100	85		100		
	14		95				
15		100					

**Notes:**  
1. See Figure 5.3

Amend 2  
Nov 2020

Amend 2  
Nov 2020

<b>Table 5.3</b>		<b>Maximum size of largest permitted single unprotected area in external walls</b> Paragraphs 5.2.8, 5.5.5 and 5.5.6			
Risk group	Minimum distance to relevant boundary (m) <sup>1</sup>	Unsprinklered firecell		Sprinklered firecell	
		Maximum largest single unprotected area (m <sup>2</sup> )	Minimum distance to adjacent unprotected areas (m <sup>2</sup> )	Maximum largest single unprotected area (m <sup>2</sup> )	Minimum distance to adjacent unprotected areas (m <sup>2</sup> )
<b>SM</b>	1	1.0	1.0	15	1.5
	2	6.0	1.5	35	2.5
	3	13	4.5	60	3.5
	4	20	5.5	96	4.0
	5	29	6.5	139	4.5
	6	40	7.5	No restriction	No restriction
<b>SI</b>	1			15	1.5
	2			35	2.5
	3			60	3.5
<b>CA</b> <b>WB</b> <b>VP</b>	1	1.0	0.5	15	1.5
	2	4.0	1.0	35	2.5
	3	10	5.0	60	3.5
	4	16	7.0	96	4.0
	5	23	8.0	139	4.5
	6	31	8.5	No restriction	No restriction
	7	40	9.5	No restriction	No restriction
	8	51	11	No restriction	No restriction
	9	64	13	No restriction	No restriction
	10	77	13.5	No restriction	No restriction
<b>WS</b>	1			15	1.5
	2			35	2.5
	3			60	3.5
	4			96	4.0
	5			139	4.5
	6			No restriction	No restriction

**Notes:**  
1. See Figure 5.3

Amend 2  
Nov 2020



Amend 2  
Nov 2020



## 5.6 Horizontal fire spread from roofs and open sided buildings

WB VP

**5.6.1** For **risk groups WB** and **VP**, in *buildings* other than offices and laboratories where the roof of an unsprinklered *firecell* is within 1.0 m of a *relevant boundary*, horizontal *fire spread* shall be resisted by either:

- a) *Fire rating* (for *fire exposure* from below) that part of the roof within 1.0 m of the *relevant boundary*. The *FRR* shall be based on the *property rating* for the *firecell*, except that *insulation* is not required, or
- b) Extending the wall, being a *fire separation* along or adjacent to the *relevant boundary*, no less than 450 mm above the roof to form a parapet.

### Parapets for unsprinklered firecells

**5.6.2** Where sprinklers are not provided, and an area of roof within 1.5 m of the *relevant boundary* is used for storage of *combustible* materials or vehicle parking, a parapet shall be provided which extends no less than 1.5 m above the roof level with an *FRR* according to the *property rating* of Paragraph 2.3. For **risk group VP** this parapet shall have an *FRR* of no less than 30 minutes.

### Roof projections

**5.6.3** If the *external wall* is required to have an *FRR*, the eaves projection shall be *constructed* with the same *FRR* as the *external wall*. Alternatively, the *external wall* shall be extended to the underside of the roof and the eaves need not be *fire rated* (see Figure 5.4).

**5.6.4** If the *external wall* is not required to have an *FRR*, roof eaves projecting from that wall need not be *fire rated* provided that no part of the eaves *construction* is closer than 650 mm to the *relevant boundary*.

**5.6.5** If the *external wall*, on its own, is not required to have an *FRR*, but roof eaves extend to within 650 mm of the *relevant boundary*, the total eaves *construction* and the *external wall* from which they project shall have *FRRs* in accordance with Paragraph 2.3 (see Figure 5.4).

Eaves *construction* includes the guttering or spouting and any other projections from the eaves, although guttering or spouting need not be *fire rated*.

Amend 2  
Nov 2020

### Open sided buildings

**5.6.6** An open sided *building* may be either a detached *building* or connected to another *building* (see Figure 5.5). For the open sided *building* to be deemed 'detached', the horizontal distance between the other *building* and the roof of the open sided *building* shall be no less than:

- a) 1.0 m for a roof area exceeding 40 m<sup>2</sup>, or
- b) 0.3 m for a roof no greater than 40 m<sup>2</sup>.

**5.6.7** Open sided *buildings* (see Figure 5.5), having only a single floor level may be *constructed* with *external walls* having 100% *unprotected area* provided that they:

- a) Have no less than two sides completely open to the environment, and
- b) Where attached to another *building*, both *buildings* are under the control of the same occupancy, and
- c) For roof areas > 40 m<sup>2</sup>, open sided *buildings* shall be no closer to a *relevant boundary* than:
  - i) 1.0 m if in **risk groups SM, SI, CA** or **WS**, or
  - ii) 3.0 m if in **risk groups WB** or **VP**, and
- d) For roof areas ≤ 40 m<sup>2</sup>, open sided *buildings* shall be no closer than 0.3 m to the *relevant boundary*.

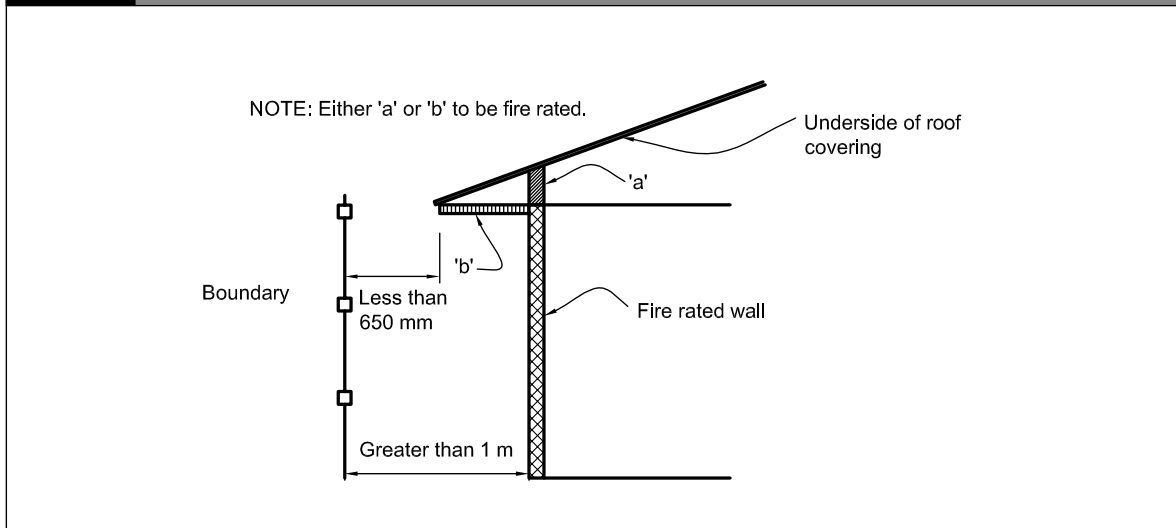
**5.6.8** Where the requirements of Paragraph 5.6.7 cannot be achieved the applicable *external wall/s* shall comply with all the requirements for the horizontal *fire spread* from *external walls* in accordance with Paragraph 5.2.

### Floor projections

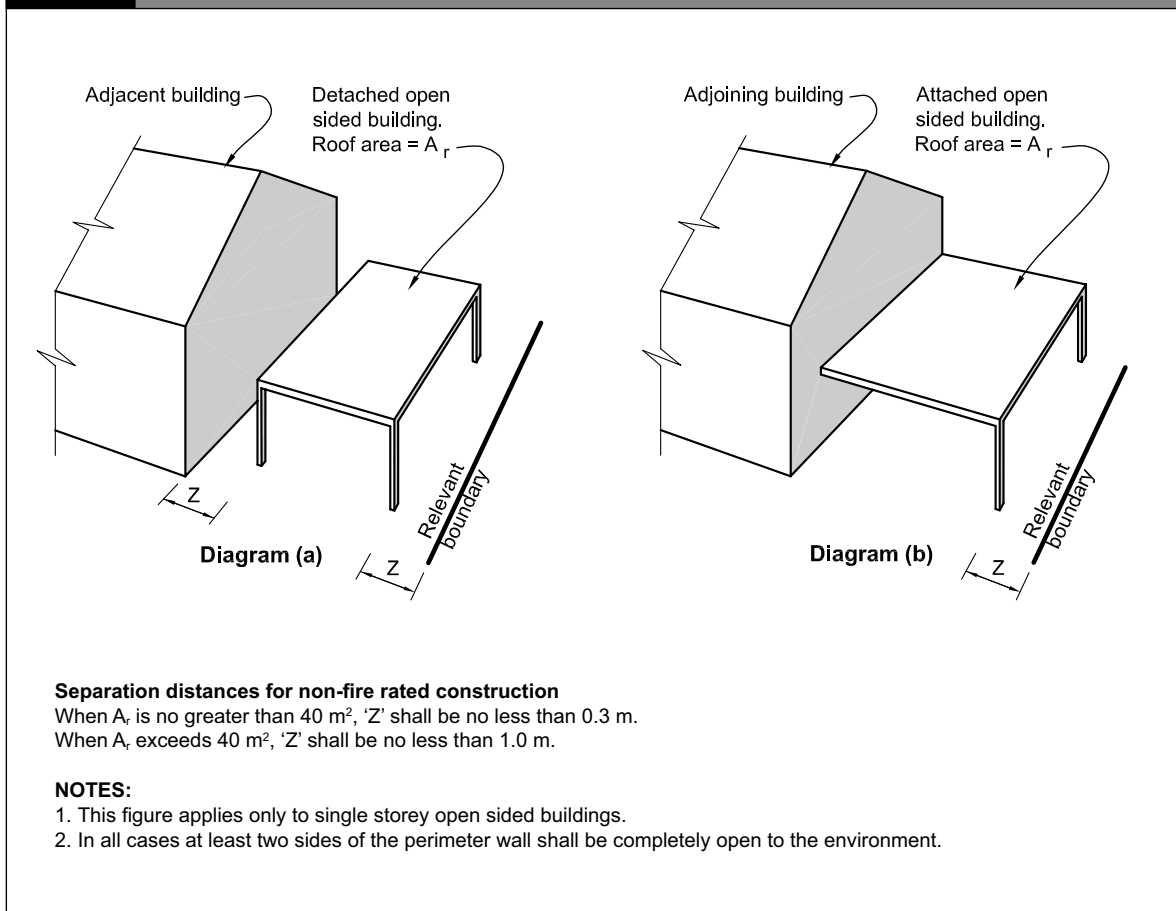
**5.6.9** If a floor projects beyond the face of any part of an *external wall* which requires a *property rating*, or any part of the projection is closer than 1.0 m to the *relevant boundary*, the floor projection shall have the same *FRR* as the floor inside the *external wall*, and exposed exterior faces of the projection shall comply with Paragraph 5.8.



**Figure 5.4** Eaves projection  
Paragraphs 5.6.3 and 5.6.5



**Figure 5.5** Open sided buildings – distance and FRR requirements  
Paragraph 5.6.6



## 5.7 Vertical fire spread

### Roofs

**SM SI** 5.7.1 Sleeping **risk groups SM** and **SI**, other property and external exitways shall be protected against vertical fire spread from roofs.

5.7.2 Protection against fire spread shall be achieved using one or more of the following methods:

- Separation by distance, and/or
- Fire rating the adjoining external wall, and/or
- Fire rating all or part of the roof, including its supporting structure, against the threat of fire from the underside, and/or
- Installing sprinklers in the firecell below the roof.

### External exitways over roofs

5.7.3 Subject to Paragraph 3.11, when an external exitway crosses a roof or is above or adjacent to a roof on the same or another building, the roof within 3.0 m of any part of the exitway and all supporting elements shall have an FRR in accordance with Paragraph 2.3.

### Primary elements

5.7.4 Primary elements providing support to an area of fire rated roof shall have an FRR of no less than that of the roof.

5.7.5 When supporting an unrated roof:

- Primary elements such as columns or walls which are required to be fire rated shall be rated from floor level to the underside of the roof framing members, and
- Any roof framing members connected to these fire rated columns or walls shall also be rated if their collapse in fire would cause the consequential collapse of the rated columns or walls.

### Fire spread from an adjacent lower roof

5.7.6 Fire spread from a roof close to and lower than an external wall in the same building (as the lower roof), or in an adjacent building on the same title shall be avoided by compliance with Paragraph 5.7.7 where firecells behind the wall contain:

- Other property, or
- Either **risk group SI** or **SM**, or
- Exitways.

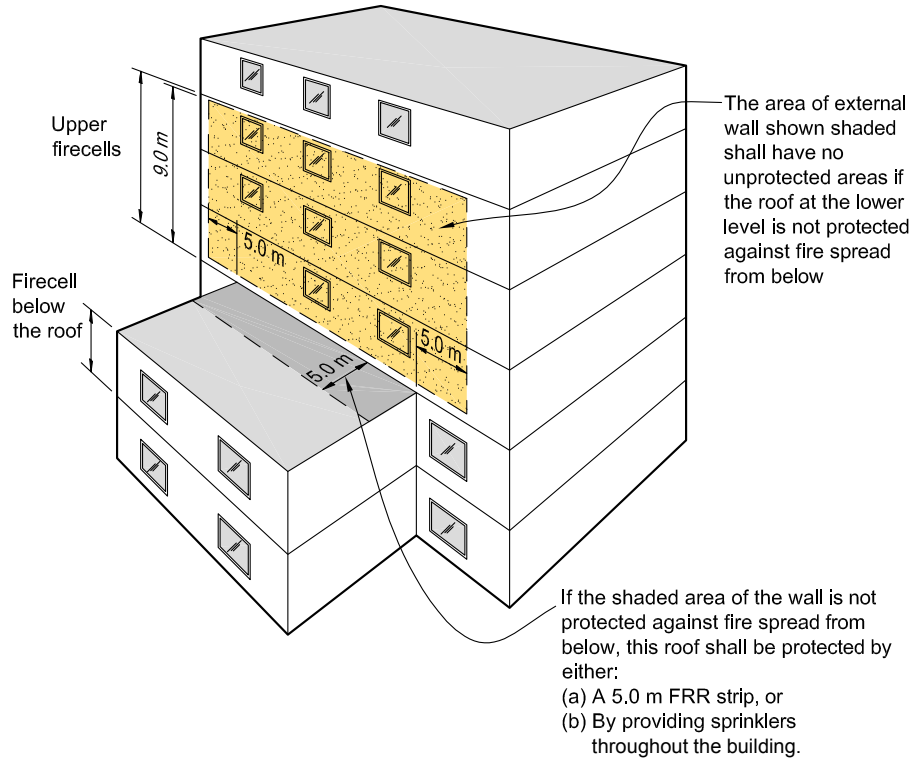
5.7.7 Where the distance between any part of an external wall and a lower roof is less than 9.0 m vertically or 5.0 m horizontally (see Figure 5.6), protective measures shall be applied either to the roof as specified in Paragraph 5.7.8 or to the wall as specified in Paragraph 5.7.9.

5.7.8 Roof protection shall be achieved by:

- Providing sprinklers throughout the building, or
- Constructing that part of the roof within 5.0 m horizontally of the wall, with an FRR in accordance with Paragraph 2.3 of the firecell below the roof.

5.7.9 External wall protection above an adjacent lower roof shall be provided by constructing the critical part of the wall (closer to the roof than 9.0 m vertically or 5.0 m horizontally (see Figure 5.6)) with an FRR in accordance with Paragraph 2.3.

**Figure 5.6** Vertical fire spread for external walls and roofs  
Paragraph 5.7.7 to 5.7.9



Amend 2  
Nov 2020

### External fire spread between different levels of the same building

**5.7.10** Except where *firecells* are sprinklered, *unprotected areas* in *external walls* shall be protected against vertical *fire spread* if any of the following conditions occur:

- SM** a) An *escape height* of 4.0 m or more in **risk group SM**, or
- CA** b) *Exitways* with an *escape height* of 4.0 m or more in **risk group CA** or 10 m or more in **risk groups WB** and **VP**, or
- WB** **VP** c) *Firecells* containing retail areas having an *escape height* of 7.0 m or more, or
- d) *Firecells* containing *other property* located one above the other.

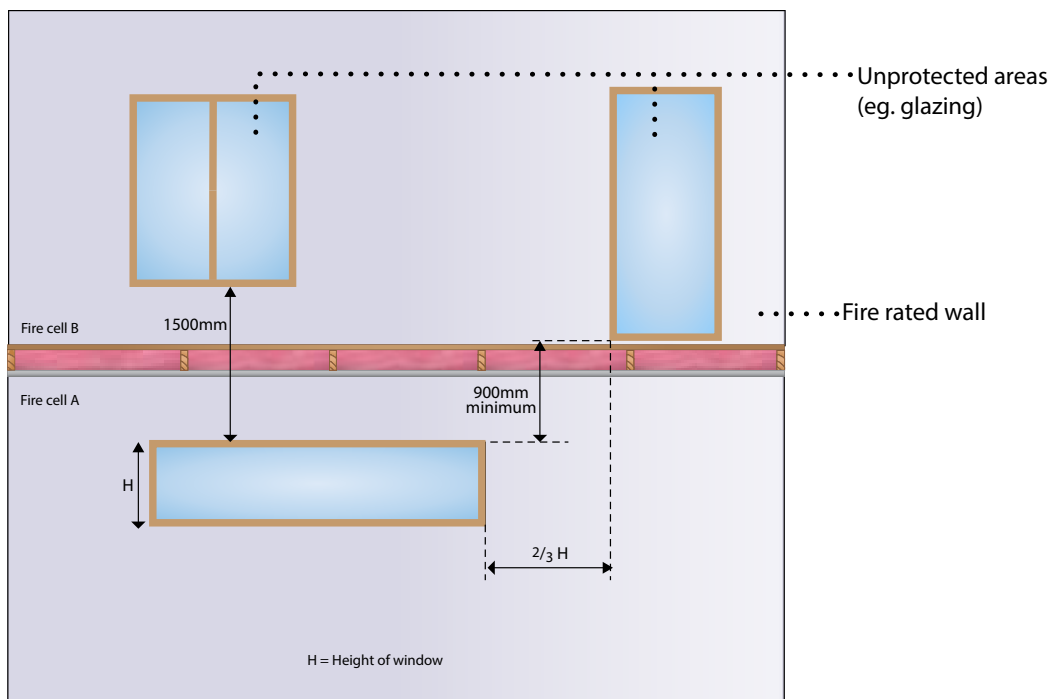
**5.7.11** If the conditions described in Paragraph 5.7.10 occur, *unprotected areas* (see Figure 5.7) in the *external walls* of the *firecells* shall be separated by no less than:

- a) 1500 mm where any parts of the *unprotected areas* are vertically aligned above one another, or
- b) 900 mm where the *unprotected areas* on one level are horizontally offset from those on the other level.

### Spandrels and apron projections

**5.7.12** Spandrels may be omitted where an apron projecting no less than 600 mm is *constructed*. Table 5.4 specifies the acceptable combinations of apron projection and spandrel height.

**Figure 5.7** Separation of unprotected areas  
Paragraph 5.7.11



Apron projection (mm)	Spandrel height (mm)
0	1500
300	1000
450	500
600	0

**5.7.13** Aprons shall extend horizontally beyond the outer corners of the *unprotected area* by no less than the apron projection distance. Aprons and spandrels shall have *FRRs* of no less than that of the floor separating the upper and lower *firecells*. Spandrels shall be rated from both sides. Aprons need only be rated from the underside.

#### Roof storage

**5.7.14** Storage of *combustible* materials on a roof is not permitted within 1.5 m of a higher *external wall* if the *adjacent building* above contains sleeping *risk groups*.

#### Roof vehicle parking

**VP 5.7.15** Where a roof used for vehicle parking is within 1.5 m of a higher *external wall* and the adjacent *building* above contains sleeping occupancies, *external wall* protection above the adjacent lower roof shall be provided by *constructing* the part of the wall (that is closer to the roof than 3.0 m vertically or 1.5 m horizontally) with an *FRR* of no less than that required from Table 2.3.

**VP 5.7.16** Vertical distances shall be measured for vehicle parking from the *building* roof level. (See Paragraph 5.6.2 for parapet protection against horizontal *fire* spread.)



## 5.8 External cladding systems

### External wall cladding materials

**5.8.1** Where *external walls* are located less than 1.0 m from a *relevant boundary*, cladding materials shall be:

- a) *Non-combustible* or *limited combustible* materials; or
- b) Tested in accordance with the relevant *standard test* in Appendix C C7.1 and achieve a Type A classification.

SI

**5.8.2** For *buildings* containing **risk group SI**, where *external walls* are located more than 1.0 m from a *relevant boundary*, cladding materials shall be:

- a) *Non-combustible* or *limited combustible* materials; or
- b) Tested in accordance with the relevant *standard test* in Appendix C C7.1 and achieve a Type A or Type B classification.

**5.8.3** In addition to the requirements in Paragraphs 5.8.1 and 5.8.2, where multi-level *buildings* have a *building height* of 10 m or more, cladding materials shall be:

- a) *Non-combustible* or *limited combustible* materials; or
- b) Tested in accordance with the relevant *standard test* in Appendix C C7.1 and achieve a Type A classification; or
- c) Part of an entire *external wall* cladding system that complies with Paragraph 5.8.4.

### External wall cladding systems for multi-level buildings with a building height $\geq$ 25 m

**5.8.4** The entire *external wall* cladding system shall be:

- a) *Non-combustible* or *limited combustible* materials; or
- b) Classified in accordance with AS 5113 and achieve a EW classification; or
- c) Tested in accordance with BS 8414-1 and satisfy the acceptance criteria in BR 135; or
- d) Tested in accordance with BS 8414-2 and satisfy the acceptance criteria in BR 135; or
- e) Tested in accordance with NFPA 285 and pass, and cladding materials shall be:
  - i) *non-combustible* or *limited combustible* materials; or
  - ii) tested in accordance with the relevant *standard test* in Appendix C C7.1 and achieve a Type A classification.

### Cavity barriers

**5.8.5** The spread of *fire* through cavities in an *external wall* shall be avoided by providing *cavity barriers* at each floor level. *Cavity barriers* shall comply with the requirements in Paragraphs 4.15.3 to 4.15.5.

Amend 2  
Nov 2020Amend 2  
Nov 2020Amend 2  
Nov 2020

# Part 6: Firefighting

## CONTENTS

- 6.1 Fire and Emergency New Zealand vehicular access
- 6.2 Information for firefighters
- 6.3 Firefighting facilities

### 6.1 Fire and Emergency New Zealand vehicular access

6.1.1 If *buildings* are located remotely from the street boundaries of a property, pavements situated on the property and likely to be used by Fire and Emergency New Zealand vehicles to reach a hard-standing shall:

- a) Be able to withstand a laden weight of up to 25 tonnes with an axle load of 8 tonnes or have a load-bearing capacity of no less than the public roadway serving the property, whichever is the lower, and
- b) Be trafficable in all weathers, and
- c) Have a minimum width of 4.0 m, and
- d) Provide a clear passageway of no less than 3.5 m in width and 4.0 m in height at site entrances, internal entrances and between *buildings*, and
- e) Provide access to a hard-standing from which there is an unobstructed path to the *building* within 20 m of:
  - i) the firefighter access into the *building*, and
  - ii) the inlets to *fire* sprinkler systems or *building fire* hydrant systems, where these are installed.

**SI** 6.1.2 For *risk group SI* only, the following requirements shall be met in addition to those in Paragraph 6.1.1:

- a) Roadway pavements shall withstand a vehicle of multiple axles spaced at no less than 2.5 m centres, and each carrying 8.2 tonnes, and
- b) Where a property includes two or more *buildings*, any one of which has a *building height* greater than 7.0 m, roadway widths shall be no less than 6.5 m, corners and bends shall have a minimum radius of 12.5 m and turning areas shall be a minimum of 25 m from wall to wall, and
- c) Hard-standings shall be provided adjacent to any *building* having a *building height* greater than 7.0 m.

**SI** 6.1.3 For *risk group SI* only, the location and extent of hard-standings shall be determined in consultation with Fire and Emergency New Zealand.

### 6.2 Information for firefighters

6.2.1 If *fire* alarm or sprinkler systems are installed, the control panel shall be located in a position close to the Fire and Emergency New Zealand attendance point and in accordance with NZS 4512, NZS 4515 and NZS 4541 as appropriate.

6.2.2 If *hazardous substances* are present in the *building*, warning signage in accordance with F8/AS1 shall be displayed.



## 6.3 Firefighting facilities

**6.3.1** The control features of *fire safety systems* shall be located at a position with ready access from street level and protected from the effects of *fire* including debris falling from upper floors.

### Fire hydrant system

**6.3.2** *Building fire* hydrant systems shall be installed as specified in Paragraph 2.2 and shall meet the requirements of NZS 4510.

### Fire and Emergency New Zealand lift control

**6.3.3** Fire and Emergency New Zealand lift control is required if the *escape height* exceeds 10 m. The control of lifts under *fire* conditions shall comply with NZS 4332.

# Part 7: Prevention of fire occurring

## CONTENTS

- 7.1 Solid fuel appliances
- 7.2 Gas-burning appliances
- 7.3 Oil-fired appliances
- 7.4 Electrical fire safety
- 7.5 Open fires

Amend 2  
Nov 2020

The design, *construction* and/or installation of certain types of fixed appliances using controlled combustion and other fixed equipment is specified as follows.

### 7.1 Solid fuel appliances

7.1.1 AS/NZS 2918, with the modifications given in Paragraph 7.1.2, is an Acceptable Solution for the installation of:

- a) Domestic solid fuel burning appliances installed in either domestic or commercial situations, and
- b) *Flue systems*.

#### 7.1.2 Modifications to AS/NZS 2918

Delete Paragraph 3.8 and substitute the following:

“3.8 Seismic restraint

The appliance and the floor protector shall be mechanically fixed to the floor itself.

The test seismic force shall be taken as the application of a horizontal force equal to 0.40 times the appliance weight acting in any direction at the mid height of the combustion chamber. The appliance shall not move, tilt or be dislodged from its installed position during the application of the test force.

The weight of the flue system and a wetback, if fitted, shall not be included in the test.”

Delete Section 7 and substitute the following:

“7.1 Ventilation

Ventilation shall be in accordance with Acceptable Solution G4/AS1.

7.2 Water heating equipment

Water heating appliances installed in conjunction with the heating appliance shall be vented and shall comply with Acceptable Solution G12/AS1.”

### 7.2 Gas-burning appliances

7.2.1 Gas-burning appliances must be installed in accordance with NZBC Clause G11.

Amend 2  
Nov 2020

## 7.3 Oil-fired appliances

**7.3.1** AS 1691, with the modifications given in Paragraph 7.3.2, is an Acceptable Solution for the installation of domestic oil-fired appliances.

### 7.3.2 Modifications to AS 1691

Delete Paragraph 2.2.3 and substitute the following:

“2.2.3 Electrical equipment

Electrical equipment shall comply with Acceptable Solution G9/AS1 or Verification Method G9/VM1.”

Delete “CSIRO durability Class 2 or better” from Paragraph 3.1.2 (b) and substitute “H5 treatment”.

Delete the Note to Paragraph 3.1.2 (d).

Delete Paragraph 3.1.4 and substitute the following:

“3.1.4 Stability

The appliance shall be mechanically fixed to the building.

The test seismic force on the fuel tank shall be taken as the application of a horizontal force in kilograms numerically equal to 0.40 times the tank volume in litres acting at the centre of the tank. The test seismic force on the appliance shall be taken as the application of a horizontal force equal to 0.40 times the appliance operating weight acting at the centre of the appliance.

The appliance and the fuel tank shall resist their respective seismic forces with no significant movement.”

Delete the words “without specific approval” from Paragraph 3.2.8 (b).

Delete Paragraph 5.1.1.

Add the following Note to 5.2.2:

“Note: Refer to Acceptable Solution G4/AS1 for ventilation requirements.”

**7.3.3** AS/NZS 2918 Sections 2 and 4 are also Acceptable Solutions for the installation of *flues* for domestic oil-fired appliances.

## 7.4 Electrical fire safety

**7.4.1** Electrical installations in *buildings* must be installed in accordance with NZBC Clause G9.

Amend 2  
Nov 2020

Chimney construction	Chimney jamb and chimney back thickness		Chimney breasts and side gathering and chimney wall thickness above the level of the gather, excluding linings (mm)
	Excluding filling and flue liner (mm)	Including filling and flue liner (mm)	
Concrete	170	255	170
Brickwork	155	230	155
Precast pumice concrete	85	170	85

## 7.5 Open fires

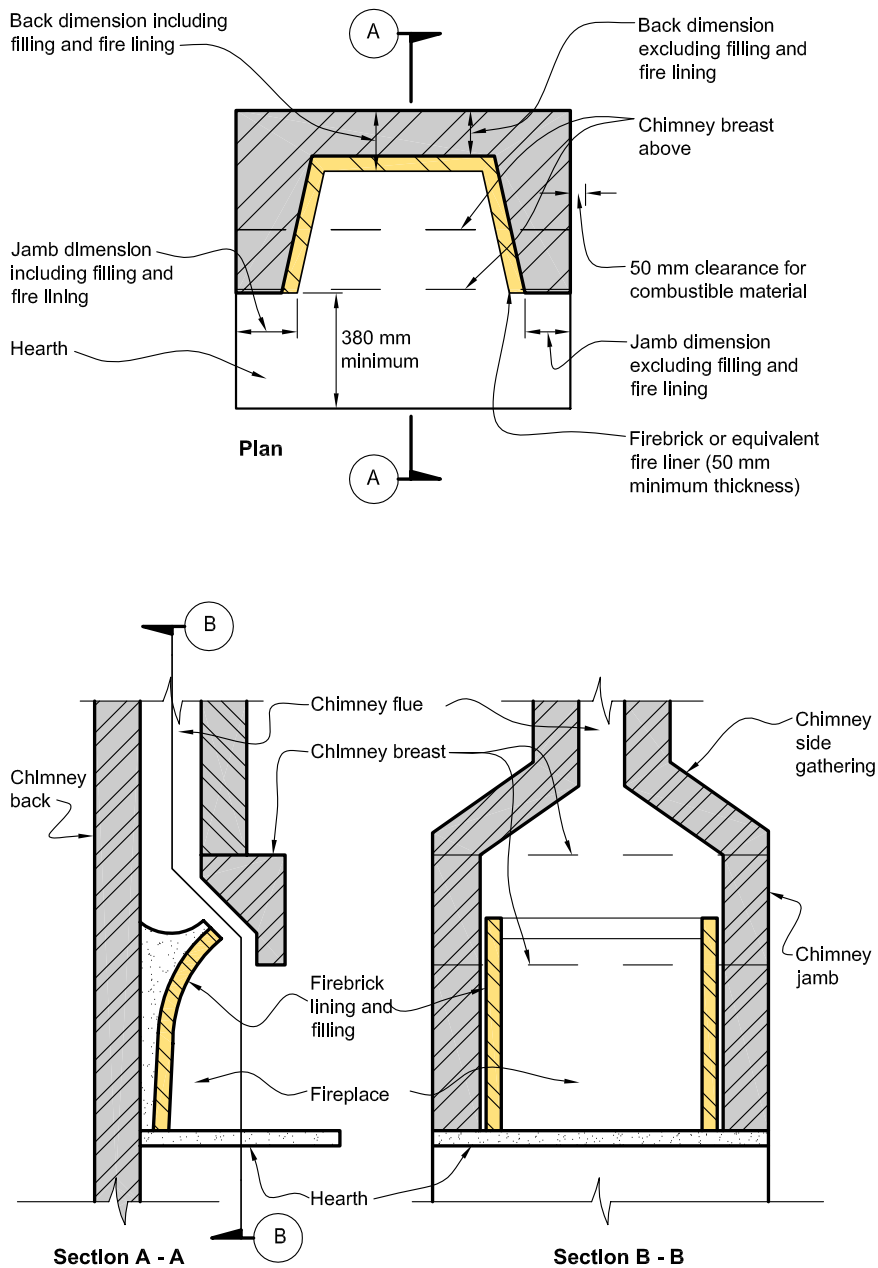
### Chimneys

**7.5.1** *Chimneys* shall be constructed in accordance with Table 7.1 and Figure 7.1. They shall have:

- a) *Fireplaces* lined with *fire* bricks having a thickness of no less than 50 mm
- b) *Fireplace* joints of *non-combustible* material and shall be sealed against air leakage
- c) *Chimney* brickwork of no less than a single skin of brick 90 mm thick plus a 65 mm thick layer of grout, and
- d) An expansion gap provided in *chimneys* containing *flue liners*. These *flue liners* shall be wrapped in a *combustible* material of thickness no less than 0.25 mm (e.g. heavy-quality *building paper*) to prevent the grout filling from bonding with the *flue liner*.

**7.5.2** Cross-sectional areas of *flues* shall be no less than 0.03 m<sup>2</sup> for an open *fireplace* (see Figure 7.2).

**Figure 7.1** Chimney terms and dimensions  
Paragraph 7.5



**7.5.3** *Flue liners* shall be one of the following types:

- a) Clay *flue liners* with rebated or socketed joints, or
- b) Imperforate clay pipes with socketed joints, or
- c) High alumina cement and kiln-burnt aggregate pipes, with rebated or socketed joints, or steel collars around joints.

The *flue liners* shall be fitted with the sockets or rebates uppermost to prevent condensate running out, and to prevent any caulking material from being adversely affected. Joints between the *flue liners*, and any space between *flue liners* and the masonry, shall be filled with weak mortar or insulating concrete (see Figure 7.2(a)).

**7.5.4** *Flue liners* are not required for:

- a) Brick *chimneys* if *constructed* of two 90 mm skins of brickwork with a 65 mm grout-filled gap between (see Figure 7.2 b)), or
- b) Ordinary concrete *chimneys*, or
- c) Precast pumice concrete *chimneys*.

**7.5.5** Clearance above roofs shall be in accordance with AS/NZS 2918 Figure 4.9.

**7.5.6** Every *fireplace* shall have a separate *flue*.

**7.5.7** *Flue* joints shall be of *non-combustible* material and sealed against air leakage.

**7.5.8** *Hearths* for *fireplaces* shall:

- a) Be *constructed* of fully grouted stones, bricks or concrete of no less than 50 mm total thickness,
- b) Extend no less than 230 mm on each side of the *fireplace* opening, and no less than 380 mm forward of the *fireplace* opening, and
- c) Have no *combustible* material closer than the clearances given in Paragraph 7.5.8 b) from the upper and lower surfaces of the *hearth*.

**7.5.9** Clearances between a *chimney* and any *combustible* material (see Figure 7.3) shall be no less than:

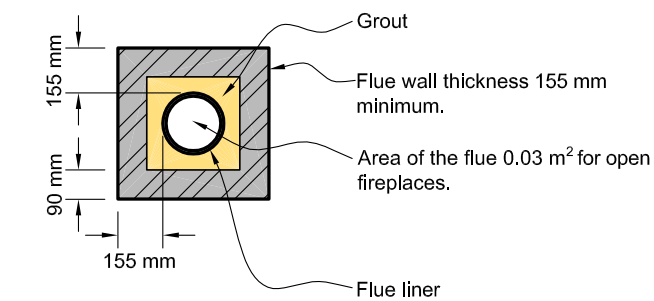
- a) 200 mm at any opening in the *flue*, or at the *fireplace* opening, and
- b) 200 mm above or below the upper surface of the *hearth*, and 75 mm from the lower surface of the *hearth*.

**7.5.10** *Hearth* edges are to be separated from *combustible* material with *insulating material* having a minimum service operating temperature of 150°C.

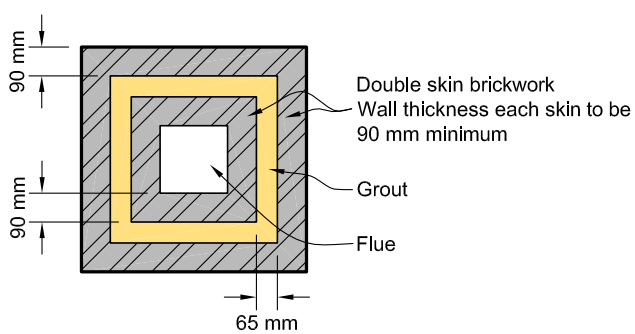
**7.5.11** A ventilated space of no less than 50 mm shall be provided between the outer face of a *fireplace*, *chimney* or *flue* and any *combustible* material.

**7.5.12** AS/NZS 2918 Sections 2 and 4 are also Acceptable Solutions for the installation of *flues* from open *fires*.

**Figure 7.2** Brick chimney flues – sections  
Paragraphs 7.5.2 and 7.5.4

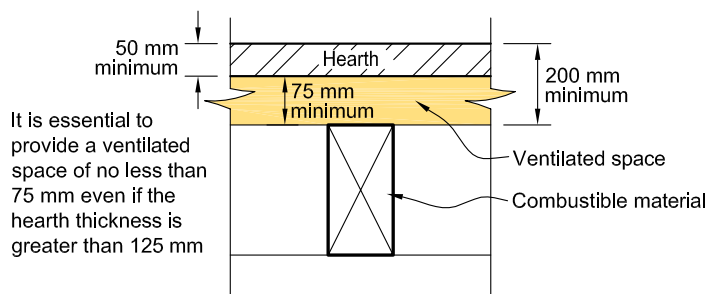
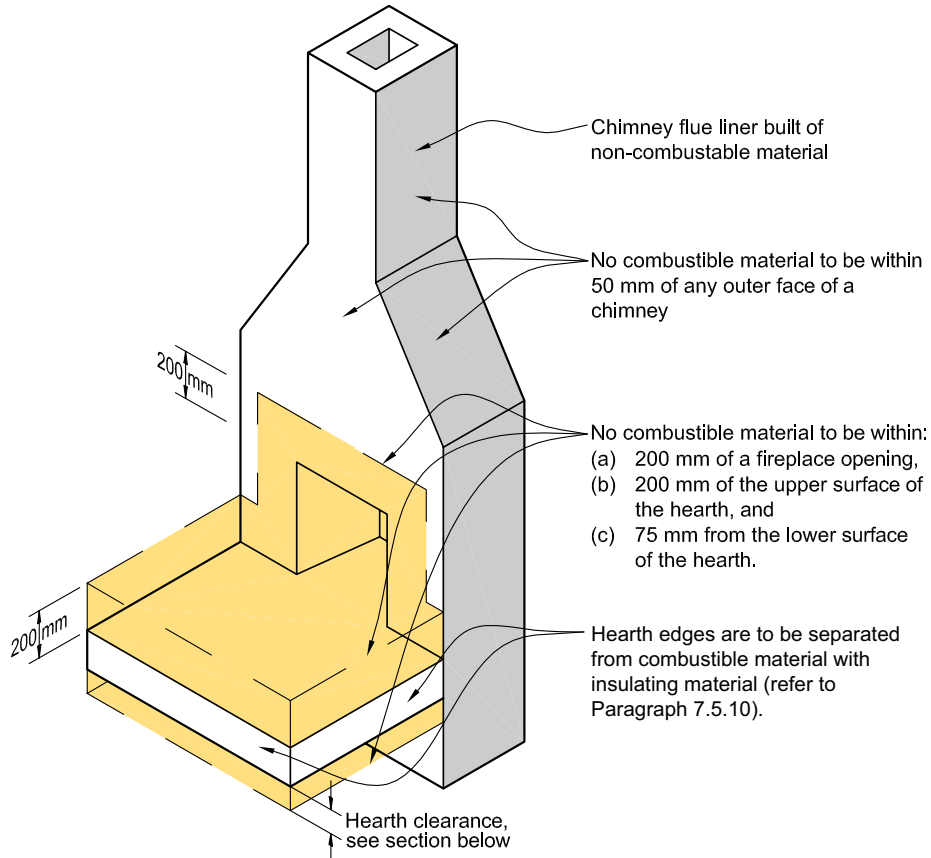


**(a) With flue liner**



**(b) Without flue liner**

**Figure 7.3** Clearance between a chimney and hearth, and combustible materials  
Paragraph 7.5.9



**Section showing minimum dimensions**



# Appendix A (normative): Fire safety systems

## A1.1 Fire alarm and sprinkler systems

**A1.1.1** Fire alarm systems used in *fire safety systems* shall satisfy the requirements of Acceptable Solution F7/AS1. Fire sprinkler systems used in *fire safety systems* shall, except where specified, also satisfy the requirements of Appendix B.

## A1.2 Requirements common to alarm systems

**A1.2.1** All fire alarm systems (except for domestic smoke alarm systems), unless otherwise specified and regardless of their means of activation, shall be provided with a means of communication with Fire and Emergency New Zealand in accordance with Acceptable Solution F7/AS1.

## A2.1 Fire safety system descriptions

**A2.1.1** The following text provides a brief description of *fire safety systems* not otherwise described in Acceptable Solution F7/AS1. See F7/AS1 for descriptions of fire alarm systems Types 1, 2, 3, 4, 5, 6 and 7, and Table 2.2 of this Acceptable Solution.

### Type 9 – Smoke control in air-handling systems

Where smoke control is required in relation to heating, ventilating or air conditioning systems, it shall comply with the requirements of either:

- a) AS/NZS 1668.1 for HVAC system shutdown and interface with any Type 4 or 7 system, or
- b) NZS 4512 to provide ancillary function output for HVAC system shutdown if a Type 4 or 7 alarm system is used as a means of smoke detection.

### Type 15 – Fire and Emergency New Zealand Lift Control

The control of lifts under *fire* conditions shall comply with NZS 4332.

### Type 18 – Fire hydrant systems for buildings

*Fire* hydrant systems shall comply with NZS 4510.

# Appendix B (normative): Fire sprinkler systems

## B1.1 Introduction

**B1.1.1** Wherever sprinklers are required by this Acceptable Solution, they shall comply with the relevant New Zealand Standard, amended as shown in Paragraphs B2.1 and B3.1.

## B2.1 Automatic fire sprinkler systems

**B2.1.1 NZS 4541** is amended as follows:

### Clause 103 Definitions

**Sprinkler system** A system including:

- (a) to (i) No change.
- (j) Delete.
- (k) Delete.
- (l) No change.

**Clause 205** Delete entire clause.

**Clause 209** Delete entire clause.

### Clause 1203 Routine Surveys

#### Clause 1203.1

Delete first two paragraphs and replace with:

“It is important that a sprinkler system at all times complies with this Standard as amended by Paragraph B2.1 of Appendix B to C/AS2 in all respects. To ensure that building alterations, changes in process or storage patterns or progressive deterioration of system components do not prejudice system compliance, a comprehensive survey shall be carried out biennially at intervals not exceeding 28 months. Such surveys shall be carried out by an independent qualified person.”

## B3.1 Residential fire sprinkler systems

**B3.1.1 NZS 4515** is amended as follows:

### Clause 1.5 Definitions

**Sprinkler system** A system including:

- (a) to (g) No change.
- (h) Delete.

**Clause 1.11** Delete entire clause.

**Clause 2.1.2** Delete.

**Clause 2.1.3** Delete.

# Appendix C (normative): Test methods

## C1.1 General

This Appendix contains test methods for confirming that specific *building elements* satisfy relevant provisions of this Acceptable Solution for Protection from Fire. It includes both established *standard tests* and other test methods for *building elements* in situations where *standard tests* are unavailable.

If these specific *building elements* have been tested to a version of a Standard in force at the date of testing and a later version of that Standard has been incorporated by reference in this Acceptable Solution, retesting is not required.

## C2.1 Flammability of floor coverings

Materials shall be assigned a critical radiant flux via either:

- Testing to ISO 9239 Reaction to fire tests for flooring – Part 1: Determination of the burning behaviour using a radiant heat source, or
- Adequacy, determined through following the methodology in C/VM2 Appendix B Table B1.

## C3.1 Flammability of suspended flexible fabrics and membrane structures

Materials shall be assigned a *flammability index* when tested to:

- AS 1530 Methods for fire tests on building materials and structures – Part 2: Test for flammability of materials.

## C4.1 Properties of lining materials

### C4.1.1 Combustibility test

Materials shall be classified as:

- Non-combustible* or *combustible* when tested to AS 1530 Methods for fire tests on building materials and structures – Part 1: Combustibility test for materials; or
- Non-combustible* when classified as A1 in accordance with BS EN 13501-1 Fire classification of construction products and building elements – Part 1:2018 Classification using test data from reaction to fire tests; or
- Limited combustible* when classified as A2 in accordance with BS EN 13501-1 Fire classification of construction products and building elements – Part 1:2018 Classification using test data from reaction to fire tests.

Amend 2  
Nov 2020

Amend 2  
Nov 2020

**C4.1.2** Material for internal surface linings shall be given a *Group Number* in accordance with Appendix A of C/VM2 via one the following methods:

- Testing to ISO 5660 Reaction-to-fire tests – Part 1: Heat release rate (cone calorimeter method), and Part 2 Smoke production rate (dynamic method), or
- Testing to ISO 9705 Fire tests – Full scale room test for surface products, or
- Equivalency determined through an approved alternative test or classification method as provided in Table C1.1, or
- Adequacy may be determined by applying the values in Table C1.2.

<b>Table C1.1 Alternative test or classification standards for Group Numbers</b>		
Requirements according to C/VM2 Appendix A using ISO 9705 or ISO 5660	Australian requirements according to NCC Specification C1.10 Clause 4 using AS ISO 9705	European Classification using EN 13501-1
Group Number 1-5	Group Number 1, and a smoke growth rate index not more than 100	Class A1, A2 or Class B and smoke production rating s1 or s2
Group Number 1	Group Number 1	Class A1, A2 or B
Group Number 2-5	Group Number 2, and a smoke growth rate index not more than 100	Class C and smoke production rating s1 or s2
Group Number 2	Group Number 2	Class C
Group Number 3	Group Number 3	Class D
Group Number 4	Group Number 4	Class E and F

<b>Table C1.2 Specified performances for some substrate and coating combinations</b>		
Coating (coating in good condition and well adhered to substrate)	Substrate	Group Number
Waterborne or solvent borne paint coatings $\leq 0.4$ mm thick Polymeric films $\leq 0.2$ mm thick	Concrete and masonry $\geq 15$ mm thick Sheet metal $\geq 0.4$ mm thick Fibre-cement board $\geq 6.0$ mm thick Porcelain, ceramic, glass, solid stone or similar tiles	1-5
Waterborne or solvent borne paint coatings $\leq 0.4$ mm thick	Gypsum plasterboard with or without paper facing $\geq 9.5$ mm thick	2-5
Waterborne or solvent borne paint coatings, varnish or stain $\leq 0.4$ mm thick $\leq 100$ g/m <sup>2</sup>	Solid wood or wood product $\geq 9.0$ mm thick $\geq 600$ kg/m <sup>3</sup> for particle boards, or $\geq 400$ kg/m <sup>3</sup> for all other wood and wood products	3
<b>Note:</b> The requirements of this table do not apply to metal faced panels with polymeric substrate.		

## C5.1 Fire resistance

**C5.1.1** *Primary elements and secondary elements, closures and fire stops* shall be assigned a *fire resistance rating (FRR)* when tested to:

- a) AS 1530 Methods for fire tests on building materials and structures – Part 4: Fire resistance tests of elements of building construction, or
- b) NZS/BS 476 Fire tests on building materials and structures – Parts 21 and 22.

**C5.1.2** *Fire stops* shall be tested:

- a) In circumstances representative of their use in service, paying due regard to the size of expected gaps to be *fire stopped*, and the nature of the *fire separation* within which they are to be used, and
- b) In accordance with AS 4072: Components for the protection of openings in fire resistant separating elements – Part 1: Service penetrations and control joints.

## C6.1 Fire doors and smoke control doors

**C6.1.1** *Fire doors* shall be evaluated in circumstances representative of their use in service, and shall comply with NZS 4520 Fire-resistant doorsets.

### Smoke control doors

**C6.1.2** A door shall be deemed to be a *smoke control door* if, in addition to the requirements in this Acceptable Solution for *smoke control doors*:

- a) The door is a *fire door* that is fitted with appropriate smoke seals, or
- b) It is *constructed* with solid core leaves. Solid timber core leaves, when used, shall have a leaf thickness of no less than 35 mm, and
- c) It is provided with smoke seals as required by this Acceptable Solution. Smoke seals shall be in continuous contact with the mating element, and located so as to minimise interruption by hardware, and

- d) The frames are constructed of timber, and the jambs are no less than 30 mm thick, and
- e) Any vision panel cut-outs are no less than 150 mm from the leaf edges, and
- f) The maximum average clearances (excluding pre-easing) are
  - i) Leaf to frame 3 mm
  - ii) Leaf to leaf 5 mm
  - iii) Leaf to top of any floor covering 10 mm, and
- g) Any additional facings are adhesive fixed, and
- h) It is provided with signage identifying it as a *smoke control door* in accordance with Acceptable Solution F8/AS1.

### Frictional forces

**C6.1.3** The forces required to open any *fire door* or *smoke control door* on an *escape route* shall not exceed 67 N to release the latch, 133 N to set the door in motion, and 67 N to open the door to the minimum required width. These forces shall be applied at the latch stile.

**SI** These requirements do not apply to horizontal sliding doors in **risk group SI** or to power-operated doors.

### Self-closing provision

**C6.1.4** All *fire* and *smoke control door* leaves shall be self-closing, and provision shall be made for the self-closing device to be adjustable during commissioning to satisfy the requirements of Paragraph C6.1.3 after installation.

**C6.1.5** Where it is desirable in normal circumstances for a *fire door* or *smoke control door* to operate freely, it is acceptable to use a self-closer mechanism which activates in the event of *fire* but does not operate at other times.

### Automatic smoke-sensing devices

**C6.1.6** Automatic smoke-sensing devices complying with NZS 4512, if used, shall be positioned within the stream of air that passes the door when the *smoke control door* is fully open.

## C7.1 Fire properties of external wall cladding systems

**C7.1.1** Cladding materials shall be classified using the values in Table C1.3 when tested in accordance with:

- a) ISO 5660 Reaction-to-fire tests – Heat release, smoke production and mass loss rate – Part 1: Heat release rate (cone calorimeter method), or
- b) AS/NZS 3837 Method of test for heat and smoke release rates for materials and properties using an oxygen consumption calorimeter.

**C7.1.2** In addition to meeting the general requirements of ISO 5660 Part 1 or AS/NZS 3837, testing shall be in accordance with the following specific requirements:

- a) An applied external heat flux of 50 kW/m<sup>2</sup>, and
- b) A test duration of 15 minutes, and
- c) The total heat release measured from start of the test, and
- d) Sample orientation horizontal, and
- e) Ignition initiated by the external spark igniter.

**C7.1.3** Timber claddings which have a *fire retardant* treatment incorporated in or applied to them shall be subjected to the regime of accelerated weathering described in ASTM D 2898 Method B with the water flow rate from Method A before testing in accordance with the requirements of Paragraph C7.1.1.

**C7.1.4** Claddings incorporating a metal facing with a melting point of less than 750°C covering a *combustible* core or insulant shall be tested as described in Paragraph C7.1.2 without the metal facing present.

Amend 2  
Nov 2020

Amend 2  
Nov 2020

Amend 2  
Nov 2020

Amend 2  
Nov 2020

**Table C1.3** Classification of cladding materials  
C7.1.1

Cladding material type	Peak heat release rate (kW/m <sup>2</sup> )	Total heat released (MJ/m <sup>2</sup> )
Type A	≤ 100	≤ 25
Type B	≤ 150	≤ 50

Amend 2  
Nov 2020